



MobileMark[®]

antenna solutions

2020-2021

Product Catalog

Moving Wireless Forward[®]

Innovative antenna designs . Responsive manufacturing . Trusted partner

Table of Contents

Testing.....	4	C-V2X, DSRC & C-ITS.....	58
GPS.....	5	Mobile.....	58
Accessories.....	6	Infrastructure.....	61
Cable Assemblies.....	6	GNSS & Multiband.....	63
Mounting Hardware.....	8	1-Element.....	63
Iridium.....	12	2-in-1 Elements.....	64
ISM & LoRaWAN.....	14	3-in-1 Elements.....	67
Device & Embedded.....	14	4-in-1 Elements.....	73
Mobile.....	16	5-in-1 Elements.....	78
Infrastructure.....	17	6-in-1 Elements.....	81
Military.....	20	7-in-1 Elements.....	83
Device & Embedded.....	20	8-in-1 Elements.....	84
Mobile.....	22	9-in-1 Elements.....	85
Infrastructure.....	26	Land Mobile Radio.....	86
RFID.....	27	Base Station.....	86
EU868.....	27	Ceiling Mount.....	89
US915.....	29	Folded Dipole.....	90
Transit & PTC.....	31	Mobile.....	92
WiFi.....	33	Yagi.....	97
Compact.....	33	Cellular IoT & M2M.....	100
Mobile.....	36	Compact.....	100
Infrastructure.....	43	Mobile.....	104
		Infrastructure.....	109



Mobile Mark's Engineering Technical Center provides a wide range of Electrical, Mechanical and Environmental testing services.

We have the ability to run a wide range of testing based on industrial & military standards. Our equipment can be used to test for Shock & Vibration standards including:

IEEE1478, EN61373, EN300-019, MIL-810G, TIA 329.2-C, IEC 60068, and SAE J1455.

IEEE 1478

Standard for Environmental Conditions for Transit Rail Car Electronic Equipment: Conditions include: temperature, humidity, atmospheric pressure, water, corrosive elements, and vibration/shock. These conditions depend upon equipment location such as under car, interior, truck mounted, and carbody mounted.

EN 300-019

Environmental conditions and environmental tests for telecommunications equipment.

TIA 329.2-C

The test conditions, and methods of measurement of vehicular antennas in the Land Mobile Services are presented for establishing conformance to the performance requirements.

SAE J1455

The recommended set of specifications for electronic equipment associated with the automotive market and is critical for testing both on- and off-road vehicles as well as heavy trucks.

EN61373

The requirements for testing items of equipment intended for use on railway vehicles which are subsequently subjected to vibrations and shock owing to the nature of railway operational environment.

MIL-810G

United States Military Standard that emphasizes tailoring an equipment's environmental design and test limits to the conditions that it will experience throughout its service life, and establishing chamber test methods that replicate the effects of environments on the equipment rather than imitating the environments themselves.

IEC 60068

a collection of methods for environmental testing of electronic equipment and products to assess their ability to perform under environmental conditions including extreme cold and dry heat.



We also have the ability to test for Water, Salt, Fog and Dust ingress standards that fall within the full range of Ingress Protection (IP) ratings. **IPX7** (dust) and **IP67** (water ingress) are some of the more common ratings we test for.

Please refer to the below specification details for all antennas with a GNSS element or GPS-only element

Global Navigations - Specifications

Antennas labeled GPS only:

Frequency Range: 1575 MHz

Covers: GPS L1, Galileo L1 & E1, Beidou B1C, QZSS L1C

Gain: 4 dBiC R.H.C.P.

Pattern: Hemispherical

Antennas labeled GNSS:

Frequency Range: 1561, 1575, & 1602 MHz

Covers: GPS L1, Galileo E1, GLONASS L1, Beidou B1C & B1I/B1Q, QZSS L1C

Gain: 4 dBiC R.H.C.P.

Pattern: Hemispherical

LNA:

Gain: 26 dB +/- 3 dB

Noise Figure: 2 dB Maximum (1.7 dB Typical)

Bias Voltage: 2.7 to 5 VDC

Current: 20 mA Maximum (10 mA Typical)

Visit our website for further details: www.mobilemark.com

Mobile Mark offers cable assemblies and mounts to make antenna installation easier. Custom cable assemblies are built to order with a variety of styles and connectors available. Cable assemblies can be used for site antennas with integrated connectors or to extend a standard mobile antenna configuration when longer runs are needed.



RG-174 Custom Cable Assemblies

RG-174: Very small (approx. 0.1"/2.5 mm) flexible cable best suited for mobile/portable applications up to 1900 MHz. It can be used in short runs up to 2.7 GHz. For miniature sized connectors it has the widest options available.



LMR-100A Custom Cable Assemblies

LMR-100A: Low Loss alternative for RG-174. It has the same size diameter (0.1 inch or 2.5 mm) and can be used with the same range of connectors. The cable is well shielded but is still flexible and easy to handle.



RG-58 Custom Cable Assemblies

RG-58: Work horse cable and is suitable for applications up to 2.7 GHz. It is best suited for cable runs under approximately 20ft (6 meters).



LL-195 Custom Cable Assemblies

LL-195: Same size cable as RG-58, and uses the same size connectors, with the added feature of lower cable losses. Low Loss-195 would be suitable for cable runs over 15 ft (4.5 meters) or in high frequency applications up to 6 GHz. This is our standard cable for applications above 2.5 GHz.



LL-195FR (Flame Retardant) Flame Retardant Custom Cable Assemblies

LL-195FR: Non-halogen (non-toxic), low smoke, fire retardant cable. It has the same diameter as LL-195, can be fitted with the same variety of connectors, and has the same cable loss.



LMR-240 Custom Cable Assemblies

LMR-240: Lower loss cable than LL-195 and best suited for longer cable runs from 20 ft - 50 ft (6 meters - 15 meters) as well as for higher frequency applications up to 6 GHz or more.



LL-400 Custom Cable Assemblies

LMR-400: Suitable for long runs & higher frequency applications. Approximately 0.405" diameter (10 mm), it might be too large for some mobile installs, but is perfect for every base station transmitter or access point.



LL-600 Custom Cable Assemblies

LMR-600: The lowest loss cable we offer. It is a premium low loss cable. Approximately 0.600" diameter (15mm) and It is suitable for base station installations where the antenna may be mounted on a tower with long runs of cable.

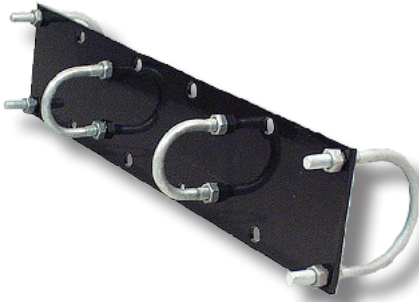

BKT1 Mount

Mounting Bracket for Horizontally Mounted Couplers

BKT1 Universal Mount Kit: The BKT1 was designed specifically for mounting the CC series coupler stackers on a vertical mast. It provides an excellent way to facilitate the connection between two antennas when they are used to send a signal in different directions.

The powder coated mounting plate can be mounted on any mast or tower leg with up to a 2 3/8" (6cm) diameter.



BKT2 Mount

Mounting Bracket for Horizontally Mounted Antennas

BKT2 Universal Mount Kit: The BKT2 was designed specifically for mounting either a Yagi or an EDX series dipole on a vertical mast. The powder coated mounting plate can be mounted on any mast or tower leg with up to a 2 3/8" diameter.

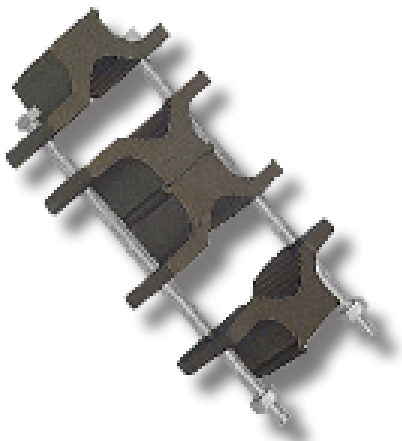

BSLLUMNT1-2 Mount

Base Station Mounting Kit

BSLLUMNT1-2 Mount Kit: designed to be used with the BSLXL and BSLLXL series base station antennas.

The mounts each consist of 4 extruded aluminum brackets and 2 hot dipped galvanized 5/16" 18 THD bolts, washers, and nuts that will handle a 3" diameter mast.



BSMNT2 Mount Base Station Mounting Kit

BKT2 Universal Mount Kit: The BKT2 mount kit is designed to be used with longer BSXL series base station antennas. The mount consists of 2 extruded aluminum brackets and stainless steel V bolts that will handle a 2 3/8" diameter mast.



HDW-AM-ID Indoor Mount for X-Wave Series

HDW-AM-ID: For indoor use for X-WAVE panel antennas. Enables flexible and optimal antenna placement.



HDW-AM-UOD Outdoor Pole or Wall Mount for X-Wave Series

HDW-AM-UOD: This adjustable bracket is used for X-WAVE Panel antennas or to secure the antenna to a pole or wall in an outdoor environment.



HDW-TMA-45-BLK Standard NATO Mount for TMA series

HDW-TMA-45-BLK: This is a standard NATO mount, i.e. ring vehicle mount, for use with TMA (Tactical Mesh Antennas). It measures 4.5" (11.4 cm) in diameter. This model is black, the HDW-TMA-45-DTS model is desert sand colored.



HDW-TMA-45NT

NATO Ring Vehicle Mount for TMA Series

HDW-TMA-45NT: 4.5" Standard NATO ring vehicle mount for use with TMA, Desert Tan.



HDW-TMA-MMB

Magnet Mount base for TMA Series

HDW-TMA-MMB: Magnetic mount for use with TMA, black.



HDW-TMA-UMB

Wall or Pole Mounting Bracket for TMA Series

HDW-TMA-UMB: Universal wall or pole mounting bracket for use with TMA, HP-TMA, and TSB.



LTM-PMK

Pole Mounting Kit for LTM Series

LTM-PMK: The LTM-PMK is a standard pole mount kit for the LTM series of antennas.



NT-PMK

Pole Mounting Kit for GPS Timing Antennas

NT-PMK: Standard Pole Mount for NT-1575 and NTG-1575 Timing antennas.



OD-WMK

Wall Mount for OD Series Antennas

OD-WMK: Antenna mounts Wall Mount for Omni-directional OD series antennas.



ODR9-2400K

Reflector Rods for OD Series Antennas

ODR9-2400K: Unique options for the OD9-2400 series are add-on Reflector Kits that beam shapes the omni pattern. Reflector options are available to provide cardioid shape in 90°, 120° & 180° patterns. These can result in improved directional gain, and isolation for reduced interference.

*Similar Reflector Rods are available for other OD models

Mobile Mark offers several mobile antennas for the Iridium satellite network. The choices include an Iridium-only antenna as well as several antennas that combine Iridium with other wireless networks including GNSS, WiFi and Cellular LTE.



DM-1620 (Iridium®)

Mobile Satellite Antenna, Iridium® Approved Antenna

Frequency: 1616 - 1626.5 MHz

Gain: 3.5 dBi

Dimensions: 3" (76mm) D x 1 1/2" (38mm) H

Shock and Vibration: EN 61373, IEEE 1478, MIL-810G, TIA-329.2-C

Water Ingress: IP67

*Also available in black



LTMG503 (2xLTE, WiFi, GNSS, Iridium®)

Multiband MIMO Antenna

Cables 1 & 2: 694 - 960 MHz, 3 dBi & 2170 - 3700 MHz, 4 dBi

Cable 3: 2.4 - 2.5 & 4.9 - 6.0 GHz, 5 dBi

Cable 4: 1616 - 1626.5 MHz, 5 dBi

Cable 5: 1561, 1575 & 1602 MHz, 5 dBi

Dimensions: 5.50" (140mm) D x 2.78" (70.6mm) H

Shock and Vibration: EN 61373, IEEE 1478, MIL-810G, TIA-329.2-C

Water Ingress: IPx7

*Specify **MLTMG503** for mag-mount version

*Specify **LTM503** (or **MLTM503**) for GPS only model

*Also available in black



LTMG507 (2xGlobal LTE, WiFi, GNSS, Iridium®)

Multiband MIMO Antenna

Cables 1 & 2: 694 - 960 MHz, 3 dBi & 1710 - 3700 MHz, 4 dBi

Cable 3: 2.4 - 2.5 & 4.9 - 6.0 GHz, 5 dBi

Cable 4: 1616 - 1626.5 MHz, 5 dBi

Cable 5: 1561, 1575 & 1602 MHz, 5 dBi

Dimensions: 5.50" (140mm) D x 2.78" (70.6mm) H

Shock and Vibration: EN 61373, IEEE 1478, MIL-810G, TIA-329.2-C

Water Ingress: IPx7

*Specify **MLTMG507** for mag-mount version

*Specify **LTM507** (or **MLTM507**) for GPS only model

*Also available in white



SMG-1620/1575 (Iridium® & GNSS)

Iridium® & GNSS Combination Surface Mount Antenna

Cable 1: 1616 - 1626.5 MHz, 3.5 dBi

Cable 2: 1561, 1575 & 1602 MHz, 5 dBi

Dimensions: 4.50" (114.3mm) D x .95" (24.1mm) H

Water Ingress: IPx5

*Specify **SM-1620/1575** for GPS only model

*Also available in black

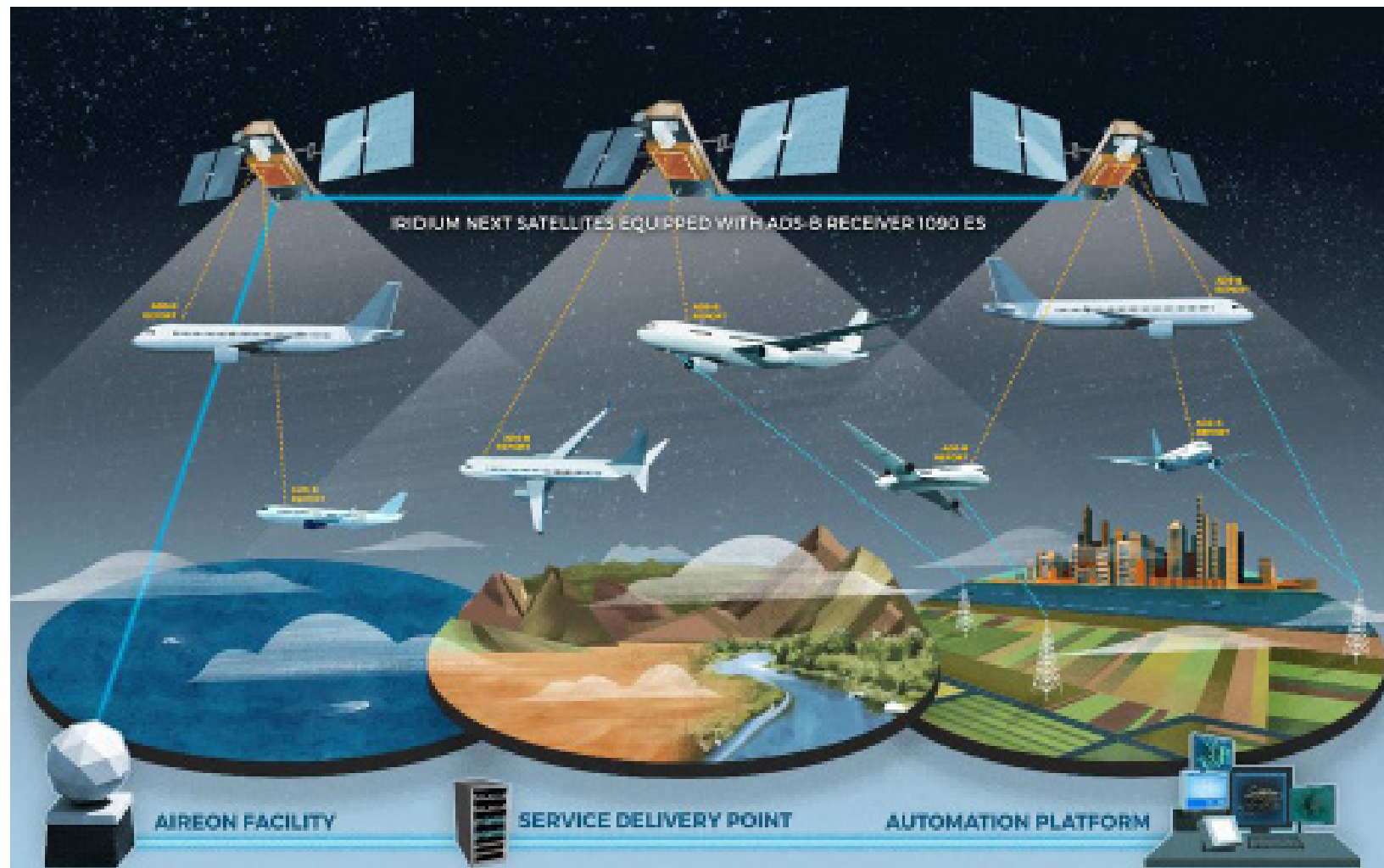

Mobile mark offers ISM (Industrial, Scientific and Medical), LoRaWAN, and Sigfox network antennas that operate on a range of frequencies (433, 868, & 915 MHz). The antennas can be embedded in or attached to devices to fixed site and infrastructure antennas that can collect data for



EM-900/2400

Dual Feed Embedded Flexible Antenna

Cable 1: 863 - 928 MHz, 2 dBi

Cable 2: 2.4 - 2.5 GHz, 2 dBi

Dimensions: 3.20" (81mm) L x .60" (24mm) H



PSTGO-868SF

Quarterwave Device Antenna

Frequency: 865 - 870 MHz

Gain: Unity

Dimensions: 3 1/2" (89mm) H

Water Ingress: IPx5

Connector: SMA Jack



PSTGO-915SE

Quarterwave Device Antenna

Frequency: 902 - 928 MHz

Gain: Unity

Dimensions: 2 7/8" (73mm) H

Water Ingress: IPx5

Connector: SMA Plug



PSTGO-915SF

Quarterwave Device Antenna

Frequency: 902 - 928 MHz

Gain: Unity

Dimensions: 3 1/2" (89mm) H

Water Ingress: IPx5

Connector: SMA Jack



PSTGO-925SF

Quarterwave Device Antenna

Frequency: 870 - 960 MHz
Gain: Unity
Dimensions: 3 3/8" (85.7mm)H
Water Ingress: IPx5
Connector: SMA Jack



PSTG2-433T

Quarterwave Device Antenna

Frequency: 420 - 470 MHz
Gain: 2 dBi
Dimensions: 6.13" (155mm) H
Water Ingress: IPx5
Connector: TNC Plug



PSTG-915S

Quarterwave Device Antenna

Frequency: 902 - 928 MHz
Gain: Unity
Dimensions: 3.2" (81mm) H
Water Ingress: IPx5
Connector: SMA Plug



HD3-915

Low Profile Heavy Duty ISM & LoRaWAN™ Antenna

Frequency: 902 - 928 MHz

Gain: 3 dBi

Dimensions: 3.52" (8.94cm) D x .50" (1.27cm) H

Shock & Vibration: EN 61373, IEEE 1478m MIL-810G

Water Ingress: IP67

* Also available **HD3-868** for 865-870 MHz



RM-433

Heavy Duty Surface Mount Antenna

Frequency: 433 MHz

Gain: Unity Gain

Dimensions: 1.7" (43mm) D x 3.1" (78mm) H

Shock & Vibration: EN 61373, IEEE 1478, MIL-810G, TIA-329.2-C

Water Ingress: IP67

*Also available in white



A1111 Series

Classic Mobile Antenna

Frequency: 806 - 960 MHz

Gain: Unity

Dimensions: 20" (51cm) H

Mounting: Standard TAD/NMO type

*Available in Brite or Black

Model Numbers & Frequencies:

A1111A (B) - 800: 806 - 896 MHz

A1111A (B) - 900: 896 - 970 MHz



A1211AC

Classic ISM & LoRaWAN™ Mobile Antenna

Frequency: 806 - 970 MHz

Gain: Unity Gain

Dimensions: 24" (61cm) max H

Mounting: Standard TAD/NMO Type

Frequency Range:

A1211AC-800: 806-896 MHz

A1211AC-900: 896-970 MHz



A2111 Series

Classic Mobile Antenna

Frequency: 806 - 960 MHz

Gain: Unity

Dimensions: 20" (50cm) H

Mounting: Standard TAD/NMO type

Model Numbers & Frequencies:

A2111A (B) - 800: 806 - 896 MHz

A2111A (B) - 900: 896 - 970 MHz



BS800UWB

Base Station Antenna

Frequency: 806 - 960 MHz

Gain: Unity

Dimensions: 1.35" (3.4cm) D x 20" (50.8cm) H



ECO5-915

Omni -Directional Antenna

Frequency: 902 - 928 MHz

Gain: 5 dBi

Dimensions: .63" (1.6cm) D x 23.5" (59.6cm) H

Shock & Vibration: EN 61373, EN 300 019-2, MIL 810G, IEC 60068, IEEE 1478

Water Ingress: IPx5



ECO5-915RN

Omni -Directional Recessed N Antenna

Frequency: 902 - 928 MHz

Gain: 5 dBi

Dimensions: .63" (1.6cm) D x 23.5" (59.6cm) H

Shock & Vibration: EN 61373, EN 300 019-2, MIL 810G, IEC 60068, IEEE 1478

Water Ingress: IPx5

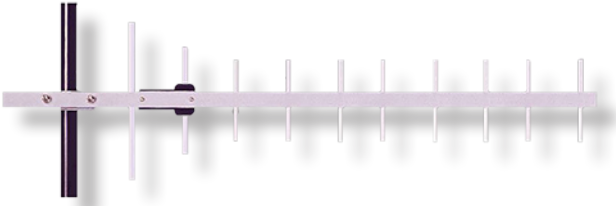

Y33810

10 Element Heavy Duty Yagi Antenna

Frequency: 870 - 960 MHz

Gain: 12.2 dBd

Dimensions: 48" (120cm) L

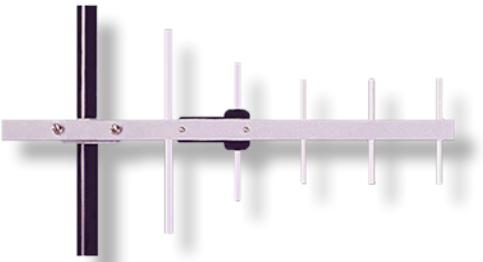

Y3385

5 Element Heavy Duty Yagi Antenna

Frequency: 806 - 970 MHz

Gain: 8.6 dBd

Dimensions: 21" (53cm) L

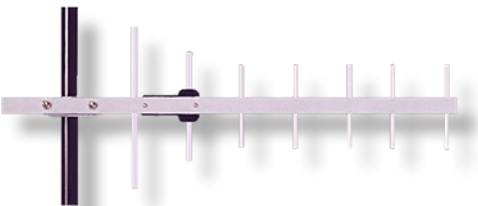

Y3387

7 Element Heavy Duty Yagi Antenna

Frequency: 902 - 928 MHz

Gain: 10.2 dBd

Dimensions: 26" (66cm) L



Y6687D

7 Element Heavy Duty Yagi Antenna

Frequency: 902 - 928 MHz

Gain: 10 dBd

Dimensions: 27" (69cm) L



YAG8-925N

5 Element Directional Yagi Antenna

Frequency: 866 - 960 MHz

Gain: 8.6 dBd

Dimensions: 21" (53cm) L

Bandwidth: <2:1

Mobile Mark offers a variety of antennas for Military use. Some will be COTS (Commercial Off the Shelf) antennas operating on commercially available networks and will be listed elsewhere in this catalog. The antennas in this section operate on frequencies that are reserved for Military use only.



PM-1350

Low Profile Directional Patch Antenna

Frequency: 1350 - 1390 MHz

Gain: 4 dBi

Dimensions: 3.4" (8.6cm) H x 3.6" (9.1cm) W x 0.5" (1.3cm) D



PSTGO-1350SE

Quarterwave Device Antenna

Frequency: 1350 - 1390 MHz

Gain: Unity

Dimensions: 2 3/8" (6.0cm) H

Water Ingress: IPx5

Connector: SMA Plug



PSTGO-1350SF

Quarterwave Device Antenna

Frequency: 1350 - 1390 MHz

Gain: Unity

Dimensions: 2 1/8" (54mm) H

Water Ingress: IPx5

Connector: SMA Jack



PSTGO-1650SF

Quarterwave Device Antenna

Frequency: 1625 - 1725 MHz

Gain: Unity

Dimensions: 1 5/8" (41mm) H

Water Ingress: IPx5

Connector: SMA Jack



PSTN2-2200
Halfwave Device Antenna

Frequency: 2.1 - 2.3 GHz
Gain: 2.3 dBi max
Dimensions: 4 3/4" H (121mm) x 1/2" (13mm) D



PSTN2-3200
Halfwave Device Antenna

Frequency: 3.1 - 3.3 GHz
Gain: 2.3 dBi max
Dimensions: 3 1/2" (89mm) H x 7/16" (11mm) D



PSTN2-4500
Halfwave Device Antenna

Frequency: 4.4 - 4.7 GHz
Gain: 2.3 dBi max
Dimensions: 3 1/2" (89mm) H x 7/16" (11mm) D



PSGN-2000S
Device Antenna with Flexible Gooseneck Extension

Frequency: 1500 - 2700 MHz
Gain: 3 dBi
Dimensions: 7.125" (18.1cm) H x .44" (1.1cm) D
Water Ingress: IP67



RMM-1400DN

Heavy Duty Direct N Surface Mount Antenna

Frequency: 1300 - 1500 MHz

Gain: 5 dBi

Dimensions: 3" (76mm) H x 1.75" (45mm) D

Shock & Vibration: EN 61373, IEEE 1478, MIL-810G, TIA-329.2-C

Water Ingress: IP67

*Specify **RMM-1400** for surface mount with cable pig tail

*Available in Military Colors



TMA-14-2VT

Tactical Mesh Surface Mount Antenna

Frequency: 1400 - 1500 MHz

Gain: 2 dBi

Dimensions: 5.5" (140mm) H x 4.4" (112mm) D



TMA-24-2CT

Tactical Mesh Surface Mount Antenna

Frequency: 2400-2500 MHz

Gain: 2 dBi

Dimensions: 5.5" (140mm) H x 4.4" (112mm) D



TMA-24A-302CT

High Performance Tactical Mesh Amplified Antenna

Frequency: 2400-2500 MHz

Gain: 2 dBi

EIRP: 32 dBm peak, 26 dBm max average

Dimensions: 5.5" (140mm) H x 4.4" (112mm) D



TMA-44-5VT

Tactical Mesh Surface Mount Antenna

Frequency: 4400 - 4800 MHz

Gain: 4 dBi

Dimensions: 5.5" (140mm) H x 4.4" (112mm) D



TMA-44A-305VT

High Performance Tactical Mesh Amplified Antenna

Frequency: 4400 - 4800 MHz

Gain: 5 dBi

EIRP: 35 dBm peak, 30 dBm max average

Dimensions: 5.5" (140mm) H x 4.4" (112mm) D



TMA-49-5VT

Tactical Mesh Surface Mount Antenna

Frequency: 4950 - 5000 MHz

Gain: 5 dBi

Dimensions: 5.5" (140mm) H x 4.4" (112mm) D



TMA-49A-305VT

High Performance Tactical Mesh Amplified Antenna

Frequency: 4950 - 5000 MHz

Gain: 5 dBi

EIRP: 34 dBm peak, 28 dBm max average

Dimensions: 5.5" (140mm) H x 4.4" (112mm) D



TMA-5X-2CT

Tactical Mesh Surface Mount Antenna

Frequency: 5400 - 5850 MHz

Gain: 2 dBi

Dimensions: 5.5" (140mm) H x 4.4" (112mm) D



TMA-5X-4VT

Tactical Mesh Surface Mount Antenna

Frequency: 5400 - 5850 MHz

Gain: 4 dBi

Dimensions: 5.5" (140mm) H x 4.4" (112mm) D



TMA-5XA-304VT

High Performance Tactical Mesh Amplified Antenna

Frequency: 4440 - 4800 MHz

Gain: 5 dBi

EIRP: 35 dBm peak, 30 dBm max average

Dimensions: 5.5" (140mm) H x 4.4" (112mm) D



TMA-5XS-7VT

Tactical Mesh Surface Mount Antenna

Frequency: 5400 - 5850 MHz

Gain: 7 dBi

Dimensions: 5.5" (140mm) H x 4.4" (112mm) D



TMA-5XSA-307VT

High Performance Tactical Mesh Amplified Antenna

Frequency: 5400 - 5850 MHz

Gain: 7 dBi

EIRP: 37 dBm peak, 31 dBm max average

Dimensions: 5.5" (140mm) H x 4.4" (112mm) D





ECO9-4700

Omni-directional Site Antenna

Frequency: 4.4 - 5.0 GHz

Gain: 9 dBi

Dimensions: 13.9" (35.3cm) H x .63" (1.6cm) D

Shock & Vibration: EN 61373, EN 300 019-2-4, MIL-810G, IEC60068, IEEE1478

Water Ingress: IPx5



ECO9-4700RN

Omni-directional Recessed N Site Antenna

Frequency: 4.4 - 5.0 GHz

Gain: 9 dBi

Dimensions: 15" (38.1 cm) H x .63" (1.6cm) D

Shock & Vibration: EN 61373, EN 300 019-2-4, MIL-810G, IEC60068, IEEE1478

Water Ingress: IPx5



XW-4X-FPS11

Circular Polarized WiFi Panel Antenna

Frequency: 4.4 - 4.6 GHz

Gain: 14 dBi

Dimensions: 8" (203.2mm) W x 8" (203.2mm) L x 1.6" (40.64mm) H

Polarization: Right Hand Circular



OD7-1350

Omni-directional Site Antenna

Frequency: 1350 - 1390 MHz

Gain: 7 dBi

Dimensions: 26 3/4" (19cm) H x 1" (25mm) D

Shock & Vibration: EN 300 019-2-4, IEC 60068

Water Ingress: IPx5

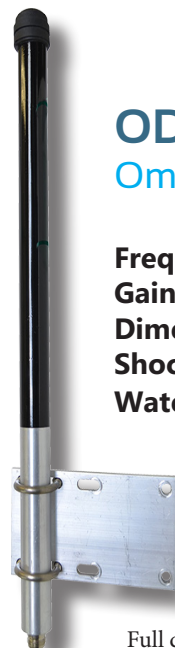

OD8-1675

Omni-directional Site Antenna

Frequency: 1625 - 1725 MHz

Gain: 8 dBi

Dimensions: 41 1/4" (105cm) H x 1" (2.5cm) D

Shock & Vibration: EN 300 019-2-4, IEC 60068

Water Ingress: IPx5

A well-designed RFID Reader Antenna will provide optimal coverage, quicker registration of RFID tags and greater hit-rates for tag reading. We offer RFID Reader antennas at different gains to allow the network designer to pick the antenna that best meets the installation requirements.



HD7-868

Heavy Duty High Vibration Panel Antenna

Frequency: 865 - 870 MHz

Gain: 7 dBic

Dimensions: 8.25" (21cm) H x 8.25" (21cm) W x 3/4" (1.9cm) D

Shock and Vibration: EN 61373, IEEE 1478, MIL-810G, TIA-329.2-C

Water Ingress: IP67



PL8-868

RFID Panel Antenna

Frequency: 868 - 870 MHz

Gain: 8 dBic

Dimensions: 8.53" (21.7cm) H x 8.53" (21.7cm) W x 1.7" (4.32cm) D

Mounting: Pole Mount



PN6-868

RFID Panel Antenna

Frequency: 865-870 MHz

Gain: 5 dBic

Dimensions: 5.75" (14.6 cm) H x 5.75" (14.6cm) W x .7" (1.8cm) D

Shock and Vibration: EN61373, IEEE 1478, MIL-810G

Water Ingress: IPx5



PN7-868N

RFID Panel Antenna

Frequency: 865 - 870 MHz

Gain: 7 dBic

Dimensions: 6.75" (172mm) H x 6.75" (172mm) W x 2" (50mm) D

Shock and Vibration: EN61373, IEEE1478, MIL-810G, TIA 329.2-C

Water Ingress: IPx7





HD7-915

Heavy Duty High Vibration Panel Antenna

Frequency: 902 - 928 MHz

Gain: 7 dBic

Dimensions: 8.25" (21cm) H x 8.25" (21cm) W x 3/4" (1.9cm) D

Shock and Vibration: EN 61373, IEEE 1478, MIL-810G, TIA-329.2-C

Water Ingress: IP67



PL8-915

RFID Panel Antenna

Frequency: 902 - 928 MHz

Gain: 8 dBic

Dimensions: 8.53" (21.7cm) T x 8.53" (21.7cm) W x 1.7" (4.32cm) D

Mounting: Pole Mount



PN6-915

RFID Panel Antenna

Frequency: 902 - 928 MHz

Gain: 5 dBic

Dimensions: 5.75" (14.6 cm) H x 5.75" (14.6cm) W x .7" (1.8cm) D

Shock and Vibration: EN61373, IEEE 1478, MIL-810G

Water Ingress: IPx5



PN7-915N

RFID Panel Antenna

Frequency: 902 - 928 MHz

Gain: 7 dBic

Dimensions: 6.75" (172mm) H x 6.75" (172mm) W x 2" (50mm) D

Shock and Vibration: EN61373, IEEE1478, MIL-810G, TIA 329.2-C

Water Ingress: IPx7



PTC (Positive Train Control) systems are being implemented across the US. The 220 MHz band is a critical piece of the overall PTC system. We offer antennas for both the wayside and the trains themselves.



SMG-220/1575 (PTC & GNSS) Combination PTC & GNSS Surface Mount Antenna

Cable 1: 220 - 224 MHz, Unity Gain

Cable 2: 1575 & 1602 MHz, 5 dBi

Dimensions: 14 7/8" (378mm) H

Shock & Vibration: EN 61373, IEEE 1478, MIL-810G, TIA-326.2-C

Water Ingress: IPx5

*Specify **SM-220/1575** for GPS only model



SMWG-PTC (PTC, WiFi, GNSS) Multiband Surface Mount Antenna

Cable 1: 220 - 222 MHz, 2 dBi

Cable 2: 2.4 - 2.5 GHz, 5 dBi

Cable 3: 1575 & 1602 MHz, 5 dBi

Dimensions: 4.2" (107mm) D x 3.2" (81mm) H

Shock & Vibration: MIL-810G, TIA 329.2-C

Water Ingress: IP67

*Specify **MGWG-PTC** for mag-mount version

*Specify **SMW-PTC** (or **MGW-PTC**) for GPS only model

*Also available in black

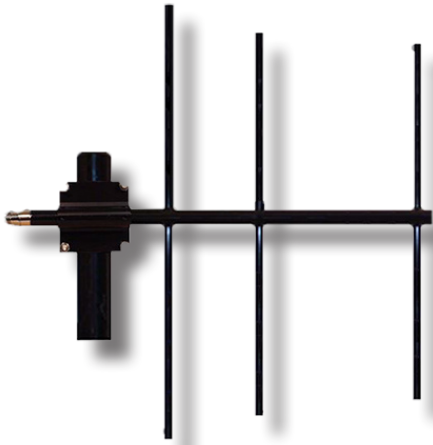

Y6623 Series

3 Element Fully Welded Yagi Antenna

Frequency: 200 - 245 MHz

Gain: 7 dBd

Dimensions: 24" (61cm) L

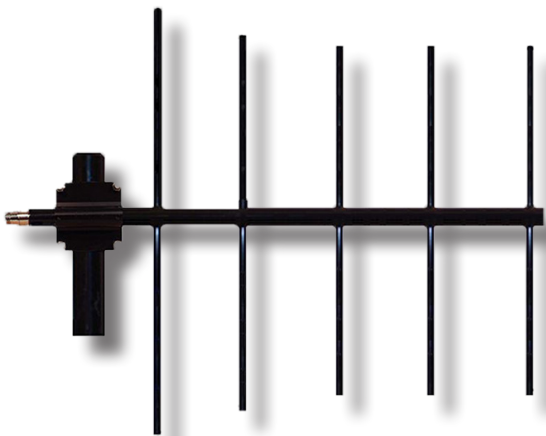

Y6625 Series

5 Element Fully Welded Yagi Antenna

Frequency: 200 - 250 MHz

Gain: 8.6 dBd

Dimensions: 52" (132cm) L x 30" (76cm) W



WA Series

Multiband, Wayside Wireless, Rail Antenna

Cable 1: 694 - 894 MHz, 2 dBi & 1710 - 2170 MHz, 5 dBi

Cable 2: 694 - 894 MHz, 2 dBi & 1710 - 2170 MHz, 5 dBi

Cable 3: 1575 MHz, LNA 26 dB, 5 dBi

Dimensions: 6.5" (2m) D x 5.3" (1.6m) H

Our line of WiFi antennas are available in a wide variety of shapes and sizes, from small embedded antennas for device connectivity to heavy duty infrastructure antennas for industrial applications.



CVL-2400/5500 Overmold WiFi Antenna

Frequency: 2.4 - 2.5 & 4.9 - 6.0 GHz

Gain: 3 dBi

Dimensions: 2.41" (61.1cm) L x .65" (16.5cm) W

Shock and Vibration: EN61373, IEEE1478, MIL 810G, TIA 329.1-C

Water Ingress: IP69



EM-2400/5500 Internal WiFi Antenna

Frequency: 2.4 - 2.5 & 4.9 - 6.0 GHz

Gain: 2 dBi

Dimensions: 1.4" (36mm) L x .48" (12mm) W



PSKN3-24/55S Quarterwave Device Antenna, SMA

Frequency: 2.4 - 2.5 & 4.9 - 6.0 GHz

Gain: 2.3 dBi

Dimensions: 3 1/8" (79mm) H @ 90° angle

Shock & Vibration: EN61373, IEEE 1478, MIL-810G, TIA-329.2-C

Water Ingress: IPx5



PSKN3-2400S

Quarterwave Device Antenna, SMA

Frequency: 2.4 - 2.5 GHz

Gain: 2.3 dBi

Dimensions: 6 1/2" (165 mm) H @ 90° angle

Shock & Vibration: EN61373, IEEE 1478, MIL-810G, TIA-329.2-C

Water Ingress: IPx5



PSKN4-2400RT

High Gain Rubber Duck Antenna, Rev. TNC

Frequency: 2.4 - 2.5 GHz

Gain: 4 dBi

Dimensions: 6 1/2" (165 mm) H when straight

Shock & Vibration: EN61373, IEEE 1478, MIL-810G, TIA-329.2-C

Water Ingress: IPx5



PSN3-2400RT

High Gain Rubber Duck Antenna, Rev. TNC

Frequency: 2.4 - 2.5 GHz

Gain: 2.3 dBi

Dimensions: 6 1/2" (165 mm) H when straight

Shock & Vibration: EN61373, IEEE 1478, MIL-810G, TIA-329.2-C

Water Ingress: IPx5



PSTGO-2400

Quarterwave Device Antenna, SMA or Reverse SMA

Frequency: 2.4 - 2.5 GHz

Gain: Unity

Dimensions: 1" (73mm) H

Water Ingress: IPx5



PSTN2-2400/5600

Halfwave Device Antenna

Frequency: 2.4 - 2.5 & 5.0 - 6.0 GHz

Gain: 2.3 dBi

Dimensions: 4 7/8" (124mm) H x 3/4" (19mm) D





A10245B

Elevated Feed Mobile Antenna

Frequency: 2.4 - 2.5 GHz

Gain: 5 dBi

Dimensions: 14" (35.6cm) H

Bandwidth: 100 MHz

Mounting: Standard TAD/NMO type



A212405B

Magnet Mount WiFi Antenna

Frequency: 2.4 - 2.5 GHz

Gain: 5 dBi

Dimensions: 10" (25.4cm)

Bandwidth: 100 MHz

Mounting: Magnet



DM2-2400

Surface Mount Dome Antenna

Frequency: 2.4 - 2.5 GHz

Gain: 2.5 dBi

Dimensions: 3" (76mm) D x 1 1/2" (38mm) H

Shock & Vibration: EN 61373, IEEE 1478, MIL-810G, TIA-329.2-C

Water Ingress: IPx7

*Also available in black



DM2-2400/5500

Surface Mount Dome Antenna

Frequency: 2.4 - 2.5 & 4.9 - 6.0 GHz

Gain: 2.5 dBi

Dimensions: 3" (76mm) D x 1 1/2" (38mm) H

Shock & Vibration: EN 61373, IEEE 1478, MIL-810G, TIA-329.2-C

Water Ingress: IPx7

*Also available in black



DM2-5500 (NXD Product instead)
Surface Mount Dome Antenna

Frequency: 5.0 - 6.0 GHz
Gain: 2.5 dBi
Dimensions: 3" (76mm) D x 1 1/2" (38mm) H
Shock & Vibration: EN 61373, IEEE 1478, MIL-810G, TIA-329.2-C
Water Ingress: IPx7
*Also available in black



ECOS5-2400
Spring Mount Antenna

Frequency: 2.4 - 2.5 GHz
Gain: 5 dBi
Dimensions: 16.25" (41.3cm) H
Water Ingress: IPx5



ECOS8-2400
Spring Mount Antenna

Frequency: 2.4 - 2.5 GHz
Gain: 8 dBi
Dimensions: 24.75" (62cm) H
Water Ingress: IPx5



ECOS6-5500
Spring Mount Antenna

Frequency: 5.0 - 6.0 GHz
Gain: 6 dBi
Dimensions: 12.5" (32cm) H
Water Ingress: IPx5



ECOS9-5500
Spring Mount Antenna

Frequency: 5.0 - 6.0 GHz
Gain: 9 dBi
Dimensions: 16.25" (41.3cm) H
Water Ingress: IPx5



HD4-2400

Low Profile Heavy Duty WiFi Antenna

Frequency: 2400 - 2485 MHz

Gain: 4 dBi

Dimensions: .52" (1.3cm) H x 2.75" (6.89cm) W

Shock & Vibration: EN 61373, IEEE1478, MIL-810G

Mounting: IP67



LTM404 (4xWiFi)

Dualband WiFi MIMO Antenna

Cables 1-4: 2.4 - 2.5 & 4.9 - 6.0 GHz

Gain: 5 dBi

Dimensions: 5.50" (14 cm) D x 2.38" (6.04cm) H

Shock and Vibration: IEEE1478, EN61373, MIL-810G, TIA 329.2-C

Water Ingress: IP67

*Specify **MLTM404** for mag-mount

**Also available in white



LTM603 (6xWiFi)

Dualband WiFi MIMO Antenna

Cables 1-6: 2.4 - 2.5 & 4.9 - 6.0 GHz

Gain: 4 dBi

Dimensions: 5.50" (14 cm) D x 2.38" (6.04cm) H

Shock and Vibration: IEEE1478, EN61373, MIL-810G, TIA 329.2-C

Water Ingress: IP67

***Also available in black



MRM3-2400/5500

Compact Surface Mount Antenna

Frequency: 2.4 - 2.5 & 4.9 - 6.0 GHz

Gain: 2.5 dBi

Dimensions: 1" (25mm) D x 1.35" (34mm) H

Shock & Vibration: EN 61373, IEEE 1478, MIL-810G, TIA-329.2-C

Water Ingress: IP67

*Also available in white



RM-WHF

Heavy Duty Surface Mount Antenna

Frequency: 1.7 - 6.0 GHz

Gain: 5 dBi

Dimensions: 1.75" (45mm) D x 3" (76mm) H

Shock & Vibration: EN 61373, IEEE 1478, MIL-810G, TIA-329.2-C

Water Ingress: IP67

*Also available in white



RM-WHF-DN

Heavy Duty Direct N Mount Antenna

Frequency: 1.7 - 6.0 GHz

Gain: 5 dBi

Dimensions: 1.75" (45mm) D x 3" (76mm) H

Shock & Vibration: EN 61373, IEEE 1478, MIL-810G, TIA-329.2-C

Water Ingress: IP67

*Also available in white



RM3-2400

Heavy Duty Surface Mount Antenna

Frequency: 2.4 - 2.5 GHz

Gain: 5 dBi

Dimensions: 1.75" (45mm) D x 3" (76mm) H

Shock & Vibration: EN 61373, IEEE 1478, MIL-810G, TIA-329.2-C

Water Ingress: IP67

*Also available in white

*Also available in a Direct N Mount, **RM3-2400DN**



RM3-5500

Heavy Duty Surface Mount Antenna

Frequency: 5.15 - 5.9 GHz

Gain: 5 dBi

Dimensions: 1.75" (45mm) D x 3" (76mm) H

Shock & Vibration: EN 61373, IEEE 1478, MIL-810G, TIA-329.2-C

Water Ingress: IP67

*Also available in white

*Also available in a Direct N Mount, **RM3-5500DN**



SMD-W-2

2xMIMO Surface Mount Antenna

Cables 1 & 2: 2.4 - 2.5 & 4.9 - 6.0 GHz

Gain: 4 dBi

Dimensions: 3.5" (89mm) D x 1.5" (38mm) H

Shock & Vibration: EN 61373, IEEE 1478, MIL-810G, TIA-329.2-C

Water Ingress: IPx7

*Also available in black



SMD-W-3

3xMIMO Surface Mount Antenna

Cables 1 - 3: 2.4 - 2.5 & 4.9 - 6.0 GHz

Gain: 4 dBi

Dimensions: 3.5" (89mm) D x 1.5" (38mm) H

Shock & Vibration: EN 61373, IEEE 1478, MIL-810G, TIA-329.2-C

Water Ingress: IPx7

*Also available in black



SMD-W-HV

High Vibration MIMO Surface Mount Antenna

Frequency: 2.4 - 2.5 & 4.9 - 6.0 GHz

Gain: 4 dBi

Dimensions: 3.5" (89mm) D x 1.5" (38mm) H

Shock & Vibration: EN 61373, IEEE 1478, MIL-810G, TIA-329.2-C

Water Ingress: IPx7

*Also available in black



ECOM5-2400
Magnet Mount Antenna

Frequency: 2.4 - 2.5 GHz
Gain: 5 dBi
Dimensions: 2.6" (66mm) Base D x 10" (25cm) H
Shock & Vibration: EN 61373, IEEE 1478, MIL-810G, TIA-329.2-C
Water Ingress: IPx7



ECOM6-5500
Magnet Mount Antenna

Frequency: 5.0 - 6.0 GHz
Gain: 6 dBi
Dimensions: 2.6" (66mm) Base D x 10" (25cm) H
Shock & Vibration: EN 61373, IEEE 1478, MIL-810G, TIA-329.2-C
Water Ingress: IPx7



ECOM9-5500
Magnet Mount Antenna

Frequency: 5.0 - 6.0 GHz
Gain: 9 dBi
Dimensions: 2.6" (66mm) Base D x 16.25" (41.3cm) H
Shock & Vibration: EN 61373, IEEE 1478, MIL-810G, TIA-329.2-C
Water Ingress: IPx7



IMAG5-2400
Magnet Mount Antenna

Frequency: 2400 - 2485 MHz
Gain: 5 dBi
Dimensions: 4 7/8" (124mm) H
Shock & Vibration: EN 61373, IEEE 1478, MIL-810G, TIA-329.2-C
Water Ingress: IP67



MGD-2400/5500 Magnet Mount Dome Antenna

Frequency: 2.4 - 2.5 & 4.9 - 6.0 GHz

Gain: 2.5 dBi

Dimensions: 3.75" (95mm) D x 1.5" (48mm) H

Shock & Vibration: EN 61373, IEEE 1478, MIL-810G, TIA-329.2-C

Water Ingress: IP67

*Also available in white



MGRM3-2400 Heavy Duty Magnet Mount Antenna

Frequency: 2.4 - 2.5 GHz

Gain: 5 dBi

Dimensions: 2 5/8" (67mm) Base D. x 3 5/8" (92mm) H

Shock & Vibration: EN 61373, IEEE 1478, MIL-810G, TIA-329.2-C

Water Ingress: IPx5

*Also available in white



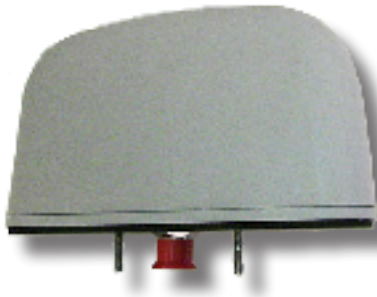

BD-2400

Bi-Directional Direct N WiFi Blade Antenna

Frequency: 2.4 - 2.5 GHz

Gain: 8 dBi

Dimensions: 7 1/2" (19cm) L x 1 1/2" (3.8cm) D x 4" (10cm) H

Water Ingress: IPx7

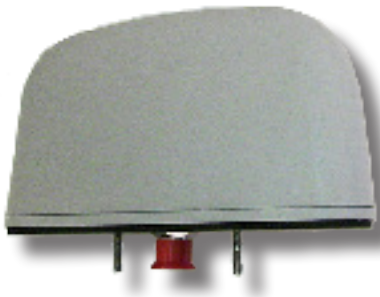

BD-5800

Bi-Directional Direct N WiFi Blade Antenna

Frequency: 5.725 - 5.85 GHz

Gain: 13 dBi

Dimensions: 7 1/2" (19cm) L x 1 1/2" (3.8cm) D x 4" (10cm) H

Water Ingress: IPx7



CLTM603 (6xWiFi)

6xMIMO WiFi Ceiling Mount Antenna

Cables 1 - 6: 2.4 - 2.5 & 4.9 - 6.0 GHz

Gain: 4 dBi

Dimensions: 5.50" (140mm) D x 2.38" (60.4mm) H

Shock & Vibration: IEEE1478, EN61373, MIL-810G, TIA 329.2-C

Water Ingress: IPx7

*Also available in black



CMD-W-2

WiFi 2.4 & CBRS MIMO Ceiling Mount Antenna

Cable 1: 2.1 - 2.7 & 3.3 - 3.8 GHz, 4 dBi

Cable 2: 2.1 - 2.7 & 3.3 - 3.8 GHz, 4 dBi

Dimensions: 3.5" (89mm) D x 1.5" (38mm) H

Shock & Vibration: IEEE1478, EN61373, MIL-810G, TIA 329.2-C

Water Ingress: IPx7

*Also available in black



CMD-W-3

WiFi 2.4 & CBRS MIMO Ceiling Mount Antenna

Cable 1: 2.1 - 2.7 & 3.3 - 3.8 GHz, 4 dBi

Cable 2: 2.1 - 2.7 & 3.3 - 3.8 GHz, 4 dBi

Cable 3: 2.1 - 2.7 & 3.3 - 3.8 GHz, 4 dBi

Dimensions: 3.5" (89mm) D x 1.5" (38mm) H

Shock & Vibration: IEEE1478, EN61373, MIL-810G, TIA 329.2-C

Water Ingress: IPx7

**Also available in black



XW-24/5XO-FPS-711

Circular Polarized Dualband WiFi Panel Antenna

Frequency: 2400 - 2500 & 5000 - 6000 MHz

Gain: 7 dBic & 11 dBic

Dimensions: 4.25" (107mm) W x 7" (184.15mm) L x 1.6" (40.64mm) H

Polarization: Right Hand Circular



XW-24O-FP7

Circular Polarized WiFi Panel Antenna

Frequency: 2.4 - 2.5 GHz

Gain: 7 dBi

Dimensions: 4.25" (107mm) W x 4.25" (107mm) L x 1.6" (40.64mm) H

Polarization: Right Hand Circular



XW-24O-FP14

Circular Polarized WiFi Panel Antenna

Frequency: 2.4 - 2.5 GHz

Gain: 14 dBi

Dimensions: 8" (203.2mm) W x 8" (203.2mm) L x 1.6" (40.64mm) H

Polarization: Right Hand Circular



XW-240-FPS11

Circular Polarized WiFi Panel Antenna

Frequency: 2.4 - 2.5 GHz

Gain: 11 dBi

Dimensions: 4.25" (107mm) W x 7" (184.15mm) L x 1.6" (40.64mm) H

Polarization: Right Hand Circular



XW-240-FPS11M

Circular Polarized 2xMIMO WiFi Panel Antenna

Connectors 1 & 2: 2.4 - 2.5 GHz

Gain: 11 dBi

Dimensions: 8" (203.2mm) W x 8" (203.2mm) L x 1.6" (40.64mm) H

Polarization: 1xRHCP, 1xLHCP



XW-5XO-FP7

Circular Polarized WiFi Panel Antenna

Frequency: 5.3 - 6.0 GHz

Gain: 7 dBi

Dimensions: 4.25" (107mm) W x 4.25" (107mm) L x 1.6" (40.64mm) H

Polarization: Right Hand Circular



XW-5XO-FP13

Circular Polarized WiFi Panel Antenna

Frequency: 5450 - 6000 MHz

Gain: 13 dBi

Dimensions: 4.25" (107mm) W x 4.25" (107mm) L x 1.6" (40.64mm) H

Polarization: Right Hand Circular

*All of these models are also available for indoor use, swapping the "O" for "I" in the model numbers.



XW-5XO-FP18

Circular Polarized WiFi Panel Antenna

Frequency: 5.45 - 5.85 GHz

Gain: 18 dBi

Dimensions: 8" (203.2mm) W x 8" (203.2mm) L x 1.6" (40.64mm) H

Polarization: Right Hand Circular



XW-5XO-FPS10

Circular Polarized WiFi Panel Antenna

Frequency: 5.45 - 6.0 GHz

Gain: 10 dBi

Dimensions: 4.25" (107mm) W x 7" (184.15mm) L x 1.6" (40.64mm) H

Polarization: Right Hand Circular



XW-5XO-FPS13

Circular Polarized WiFi Panel Antenna

Frequency: 5.45 - 6.0 GHz

Gain: 13 dBi

Dimensions: 4.25" (107mm) W x 7" (184.15mm) L x 1.6" (40.64mm) H

Polarization: Right Hand Circular

*All of these models are also available for indoor use, swapping the "O" for "I" in the model numbers.



XW-5XO-FPS13M2

Circular Polarized 2xMIMO WiFi Panel Antenna

Connectors 1 & 2: 5.45 - 6.0 GHz

Gain: 13 dBi

Dimensions: 4.25" (107mm) W x 7" (184.15mm) L x 1.6" (40.64mm) H

Polarization: 1xRHCP, 1xLHCP



XW-5XO-FPS13M3

Circular Polarized 3xMIMO WiFi Panel Antenna

Connectors 1 - 3: 5.45 - 6.0 GHz

Gain: 13 dBi

Dimensions: 8" (203.2mm) W x 8" (203.2mm) L x 1.6" (40.64mm) H

Polarization: 2xRHCP, 1xLHCP



XW-24O-H10

Circular Polarized WiFi Antenna

Frequency: 2.4 - 2.5 GHz

Gain: 10 dBi

Dimensions: 4.55" (115.57mm) W x 6.28" (159.512mm) L x 4.3" (109.22mm) H

Polarization: Right Hand Circular



XW-24O-H13

Circular Polarized WiFi Antenna

Frequency: 2.3 - 2.5 GHz

Gain: 13 dBi

Dimensions: 5.75" (115mm) W x 6.28" (159mm) L x 5.75" (146mm) H

Polarization: Right Hand Circular

*All of these models are also available for indoor use, swapping the "O" for "I" in the model numbers



XW-240-OH7G

Circular Polarized WiFi Antenna

Frequency: 2.4 - 2.5 GHz

Gain: 7 dBi

Dimensions: 4" (106mm) W x 4" (106mm) L x 2.45" (62.23mm) H

Polarization: Right Hand Circular

*Also available in white

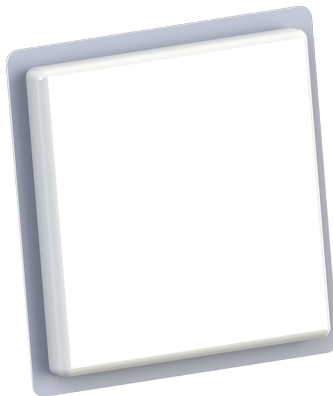

PND10-2400/5500

6xMIMO WiFi Directional Panel Antenna

Frequency: 2.4 - 2.5 & 4.9 - 6.0 GHz

Gain: 8 dBi & 10 dBi

Dimensions: 13.50 (34cm) W x 13.50" (34cm) H x 1.96" (5cm) D

Number of Connections: 6



PND8-2400/5500

MIMO WiFi Sector Panel Antenna

Frequency: 2.4 - 2.5 & 4.9 - 6.0 GHz

Gain: 8 dBi

Dimensions: 12.5" (32cm) H x 3" (8cm) W x 1.25" (3cm) D

Shock & Vibration: EN300 019-2-4, IEC 60068

*Available with 2xMIMO or 3xMIMO



PS12-2400-90

90° Directional WiFi Sector Panel Antenna

Frequency: 2.4 - 2.5 GHz

Gain: 12 dBi

Bandwidth: 90° AZ, 22° EL

Dimensions: 12.5" (32cm) H x 3" (8cm) W x 1.25" (3cm) D

Shock & Vibration: EN300 019-2-4. IEC 60068



PS10-5500-120

120° Directional WiFi Sector Panel Antenna

Frequency: 5.0 - 6.0 GHz

Gain: 10 dBi

Bandwidth: 120° AZ, 110° EL

Dimensions: 12.5" (32cm) H x 3" (8cm) W x 1.25" (3cm) D

Shock & Vibration: EN300 019-2-4. IEC 60068



PS11-5500-90

90° Directional WiFi Sector Panel Antenna

Frequency: 5.0 - 6.0 GHz

Gain: 10 dBi

Bandwidth: 90° AZ, 12° EL

Dimensions: 12.5" (32cm) H x 3" (8cm) W x 1.25" (3cm) D

Shock & Vibration: EN300 019-2-4. IEC 60068



PS12-5500-60

60° Directional WiFi Sector Panel Antenna

Frequency: 5.0 - 6.0 GHz

Gain: 12 dBi

Bandwidth: 60° AZ, 12° EL

Dimensions: 12.5" (32cm) H x 3" (8cm) W x 1.25" (3cm) D

Shock & Vibration: EN300 019-2-4. IEC 60068



PS14-5500-45

45° Directional WiFi Sector Panel Antenna

Frequency: 5.0 - 6.0 GHz

Gain: 14 dBi

Bandwidth: 45° AZ, 11° EL

Dimensions: 12.5" (32cm) H x 3" (8cm) W x 1.25" (3cm) D

Shock & Vibration: EN300 019-2-4. IEC 60068

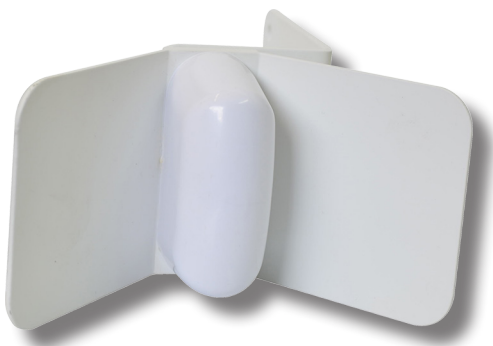

SCR-2400/5500

Corner Reflector Antenna

Frequency: 2.4 - 2.5 & 4.9 - 6.0 GHz

Gain: 9 dBi & 12 dBi

Dimensions Aperture: 3" x 5.5" (76 mm x 140 mm)

Dimensions Panels: 3" x 3" ea (76 mm x 76 mm)

Shock & Vibration: EN300 019-2-4. IEC 60068

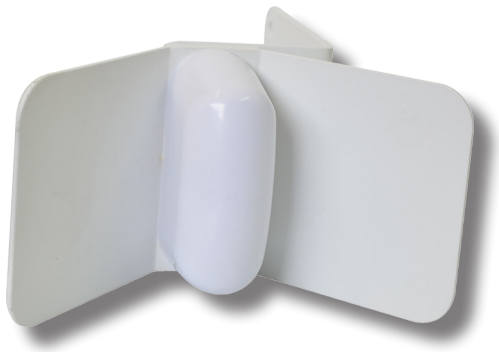

SCR9-2400
Corner Reflector Antenna

Frequency: 2300 - 2600 GHz
Gain: 9 dBi
Dimensions Aperture: 3" x 5.5" (76 mm x 140 mm)
Dimensions Panels: 3" x 3" ea (76 mm x 76 mm)
Shock & Vibration: EN300 019-2-4. IEC 60068



SCR12-2400
Corner Reflector Antenna

Frequency: 2300 - 2600 MHz
Gain: 12 dBi
Dimensions Aperture: 7" x 10.5" (178 mm x 266 mm)
Dimensions Panels: 7" x 7" (178 mm x 178 mm)
Shock & Vibration: EN300 019-2-4. IEC 60068

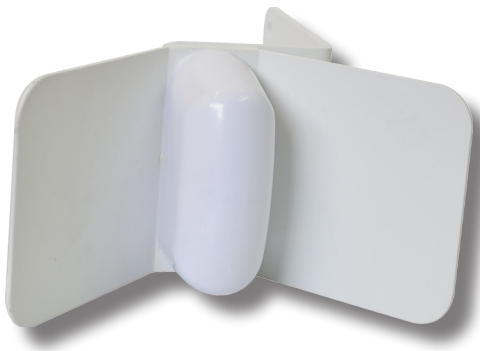

SCR10-5250
Corner Reflector Antenna

Frequency: 5.15 - 5.35 GHz
Gain: 10 dBi
Dimensions Aperture: 3" x 5.5" (76 mm x 140 mm)
Dimensions Panels: 3" x 3" ea (76 mm x 76 mm)
Shock & Vibration: EN300 019-2-4. IEC 60068

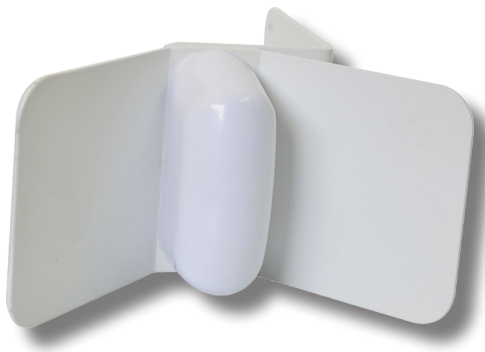

SCR12-5725
Corner Reflector Antenna

Frequency: 5.72 - 5.93 GHz
Gain: 12 dBi
Dimensions Aperture: 3" x 5.5" (76 mm x 140 mm)
Dimensions Panels: 3" x 3" ea (76 mm x 76 mm)
Shock & Vibration: EN300 019-2-4. IEC 60068



YAG12-5500

Directional WiFi Sector Yagi Antenna

Frequency: 4.4 - 5.4 & 5.47 - 6.0 GHz

Gain: 10 & 12 dBi

Dimensions: 2.75" (7cm) H x 7.5" (19cm) L x .56" (1.4cm) W

Shock & Vibration: EN300 019-2-4. IEC 60068

Water Ingress: IPx5



YAG8-W

Directional WiFi Sector Yagi Antenna

Frequency: 2400 - 2485 MHz & 4.9 - 6.0 GHz

Gain: 8 dBi

Dimensions: 2.75" (7cm) H x 7.5" (19cm) L x .56" (1.4cm) W

Shock & Vibration: EN300 019-2-4. IEC 60068

Water Ingress: IPx5



BS2400XL3 Series

WiFi Base Station Antenna

Frequency: 2400 - 2500 MHz

Gain: 3 dBd

Dimensions: 18" (46cm) L x 1" (2.5cm) D

Bandwidth: 100 MHz



DOD5-2400/5500

Omni-Directional WiFi MIMO Antenna

Frequency: 2.4 - 2.5 GHz & 5150 - 5925 MHz

Gain: 5 dBi

Dimensions: 29 5/8" (75cm) H x 1" (3cm) D

Shock & Vibration: EN300 019-2-4. IEC 60068



ECO5-2400
Omni-Directional WiFi Antenna

Frequency: 2.4 - 2.5 GHz
Gain: 5 dBi
Dimensions: 14" (35.6cm) H x .63" (1.6cm) D
Shock & Vibration: EN 61373, EN 300 019-2-4, MIL 810G, IEC 60068, IEEE 1478
Water Ingress: IPx5



ECO5-2400/5500
Omni-Directional WiFi Antenna

Frequency: 2.4 - 2.5 & 5.0 - 6.0 GHz
Gain: 5 dBi
Dimensions: 14" (35.6cm) H x .63" (1.6cm) D
Shock & Vibration: EN 61373, EN 300 019-2-4, MIL 810G, IEC 60068, IEEE 1478
Water Ingress: IPx5



ECO8-2400
Omni-Directional WiFi Antenna

Frequency: 2.4 - 2.5 GHz
Gain: 5 dBi
Dimensions: 23" (58.4cm) H x .63" (1.6cm) D
Shock & Vibration: EN 61373, EN 300 019-2-4, MIL 810G, IEC 60068, IEEE 1478
Water Ingress: IPx5



ECO6-5500
Omni-Directional WiFi Antenna

Frequency: 5.0-6.0 GHz
Gain: 6 dBi
Dimensions: 10" (25.4cm) H x .63" (1.6cm) D
Shock & Vibration: EN 61373, EN 300 019-2-4, MIL 810G, IEC 60068, IEEE 1478
Water Ingress: IPx5



ECO9-5500

Omni-Directional WiFi Antenna

Frequency: 5.0 - 6.0 GHz

Gain: 9 dBi

Dimensions: 14" (35.6cm) H x .63" (1.6cm) D

Shock & Vibration: EN 61373, EN 300 019-2-4, MIL 810G, IEC 60068, IEEE 1478

Water Ingress: IPx5



ECO12-5800

Omni-Directional WiFi Antenna

Frequency: 5.8 GHz

Gain: 12 dBi

Dimensions: 18" (45.7cm) H x .63" (1.6cm) D

Shock & Vibration: EN 61373, EN 300 019-2-4, MIL 810G, IEC 60068, IEEE 1478

Water Ingress: IPx5



MOD3-2400

Omni-Directional WiFi Antenna, Marine

Frequency: 2.4 - 2.5 GHz

Gain: 3 dBi

Dimensions: 14" (35.6cm) H x 1" (25mm) D

Shock & Vibration: EN 300 019-2-4, IEC 60068

Water Ingress: IPx5



OD5-2400/5500MOD2

Vibration Resistant Omni-Directional WiFi Antenna

Frequency: 2.4 & 5 GHz

Gain: 5 dBi

Dimensions: 13" (33cm) H x 1" (25mm) D

Shock & Vibration: EN 300 019-2-4, IEC 60068

Water Ingress: IPx5



OD3-2400

Omni-Directional SiteAntenna

Frequency: 2.4 - 2.5 GHz

Gain: 3 dBi

Dimensions: 14" (36cm) H x 1" (25mm) D

Shock & Vibration: EN 300 019-2-4, IEC 60068

Water Ingress: IPx5



OD3-2400MOD2

Vibration Resistant Omni-Directional WiFi Antenna

Frequency: 2.4 - 2.5 GHz

Gain: 3 dBi

Dimensions: 14" (35.6cm) H x 1" (25mm) D

Shock & Vibration: EN 300 019-2-4, IEC 60068

Water Ingress: IPx5



OD6-2400

Omni-Directional WiFi Antenna

Frequency: 2.4 - 2.5 GHz

Gain: 6 dBi

Dimensions: 17" (43cm) H x 1" (25mm) D

Shock & Vibration: EN 300 019-2-4, IEC 60068

Water Ingress: IPx5



OD6-2400MOD2

Vibration Resistant Omni-Directional WiFi Antenna

Frequency: 2.4 - 2.5 GHz

Gain: 6 dBi

Dimensions: 17" (43cm) H x 1" (25mm) D

Shock & Vibration: EN 300 019-2-4, IEC 60068

Water Ingress: IPx5



OD9-2400

Omni-Directional WiFi Antenna

Frequency: 2.4-2.5 GHz

Gain: 9 dBi

Dimensions: 29" (74cm) H x 1" (25mm) D

Shock & Vibration: EN 300 019-2-4, IEC 60068

Water Ingress: IPx5

OD9-2400MOD2

Vibration Resistant Omni-Directional Antenna

Frequency: 2.4-2.5 GHz

Gain: 9 dBi

Dimensions: 29" (74cm) H x 1" (25mm) D

Shock & Vibration: EN 300 019-2-4, IEC 60068

Water Ingress: IPx5



OD12-2400

Omni-Directional Site Antenna

Frequency: 2.4 - 2.5 GHz

Gain: 12 dBi

Dimensions: 41" (104cm) H x 1" (25mm) D

Shock & Vibration: EN 300 019-2-4, IEC 60068

Water Ingress: IPx5



ITS trials need dependable, consistent wireless coverage whether they rely on DSRC or C-V2X at 5.9 GHz. Infrastructure antennas can be used on Roadside Units (RSU) installed along highways and roads or at intersections.



ECOM6-5900 Mag-mount Antenna

Frequency: 5850 - 5925 MHz

Gain: 6 dBi

Dimensions: 10" (25cm) H x 2.6" (66mm) Dia. mag base

Water Ingress: IPx5



ECOM9-5900 Mag-mount Antenna

Frequency: 5850 - 5925 MHz

Gain: 9 dBi

Dimensions: 13.75" (34.9cm) H x 2.6" (66mm) Dia. mag base

Water Ingress: IPx5



ECOS9-5900DN Spring Mount Direct N Mobile Antenna

Frequency: 5800 - 5925 MHz

Gain: 9 dBi

Dimensions: 16.25" (41.3cm) H x .62" (1.6cm) D

Water Ingress: IPx5



IW-5900 Inside Window Mount Antenna

Frequency: 5850 - 5925 MHz

Gain: 6 dBi

Dimensions: 1.63" (4.2mm) D x 1.61" (4.1mm) H

Shock & Vibration: EN 61373, IEEE 1478, MIL-801-G, TIA-329.2-C

Water Ingress: IPx5



IWG-5900/1575 (DSRC & GNSS)
 Inside Window Mount Antenna

Cable 1: 5850 - 5925 MHz, 6 dBi
Cable 2: 1561, 1575 & 1602 MHz, 5 dBi
Dimensions: .47" (12mm) H x 3.56" (91mm) W x 2.41: (61mm) D
Shock & Vibration: EN 61373, IEEE 1478, MIL-801-G, TIA-329.2-C
Water Ingress: IPx5
 *Specify **IW-5900/1575** for GPS only model



MAGG6-5900/1575 (DSRC & GNSS)
 Omni-directional Mag-mount Antenna

Cable 1: 5850 - 5925 MHz, 6 dBi
Cable 2: 1561, 1575 & 1602 MHz, 5 dBi
Dimensions: 5.5" (140mm) H x 2 5/8" (67mm) Dia. Base
Shock & Vibration: EN 61373, TIA-329.2-C
Water Ingress: IPx5
 *Specify **MAG6-5900/1575** for GPS only model



SMG6-5900/1575 (DSRC & GNSS)
 Omni-directional Surface Mount Antenna

Cable 1: 5850 - 5925 MHz, 6 dBi
Cable 2: 1561, 1575 & 1602 MHz, 5 dBi
Dimensions: 5.3" (135mm) H x 2 5/8" (67mm) Dia. Base
Shock & Vibration: EN 61373, TIA-329.2-C
Water Ingress: IPx5
 *Specify **SM6-5900/1575** for GPS only model



SMWG-313 (2xDSRC & GNSS)
 GPS Multiband Surface Mount Antenna

Cables 1 & 2: 5850 - 5925 MHz, 7 dBi
Cable 3: 1561, 1575 & 1602, 5 dBi
Dimensions: 4.2" (107mm) D x 3.2" (81mm) H (add 1/2" (31mm) for mag base)
Shock & Vibration: IEEE1478, EN 61373. MIL-810G, TIA 329.2-C
Water Ingress: IP67
 *Specify **MGWG-313** for mag-mount model
 *Specify **SMW-313** (or **MGW-313**) for GPS model
 *Also available in black



SMWG-314 (LTE, DSRC, GNSS) GPS Multiband Surface Mount Antenna

Cable 1: 694 - 960 MHz, 3 dBi & 1710 - 3700 MHz, 4 dBi

Cable 2: 5.8 - 6.0 GHz, 7 dBi

Cable 3: 1561, 1575 & 1602 MHz, 5 dBi

Dimensions: 4.2" (107mm) D x 3.2" (81mm) H (add 1/2" (31mm) for mag base)

Shock & Vibration: IEEE1478, EN 61373, MIL-810G, TIA 329.2-C

Water Ingress: IP67

*Specify **MGWG-314** for mag-mount model

*Specify **SMW-314** (or **MGW-314**) for GPS only model

*Also available in black



MXFG-5900 (2xDSRC & GNSS) MaxFin Stud Mount Antenna

Cables 1 & 2: 5.8 - 6.0 GHz, 4 dBi

Cable 3: 1561, 1575 & 1602 MHz, 5 dBi

Dimensions: 7.50" (19cm) D x 2.50" (6.4cm) H

*Width-esp for Ford Explorer! 2.25" (5.7cm)

*Specify **MMXFG-5900** for mag-mount model

*Specify **MXF-5900** (or **MMXF-5900**) for GPS only model



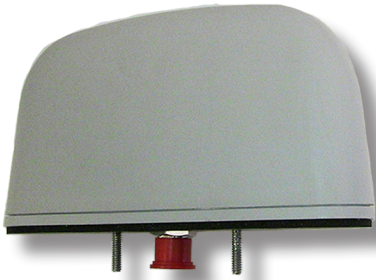

BD-5900

Bi-directional C-V2X/DSRC Blade Antenna

Frequency: 5850 - 5925 MHz

Gain: 13 dBi

Dimensions: 7 1/2" (19cm) L x 1 1/2" (3.8cm) W x 4" (10cm) H

Water Ingress: IPx7



ECO6-5900

Omni-directional Antenna

Frequency: 5850 - 5925 MHz

Gain: 6 dBi

Dimensions: .63" (1.6cm) D x 10" (25.4cm) H

Shock & Vibration: EN 61373, EN 300 019-2-4, MIL 810G, IEC 60068, IEEE 1478

Water Ingress: IPx5



ECO6-5900RN

Omni-directional Recessed N Antenna

Frequency: 5850 - 5925 MHz

Gain: 6 dBi

Dimensions: .63" (1.6cm) D x 10 5/8" (25.4cm) H

Shock & Vibration: EN 61373, EN 300 019-2-4, MIL 810G, IEC 60068, IEEE 1478

Water Ingress: IPx5

*Can be mounted directly on a device



OD5-5900MOD2

Heavy Duty Vibration Resistant Omni-directional Antenna

Frequency: 5850 - 5925 MHz

Gain: 5 dBi

Dimensions: 1" (25mm) D x 12.9" (32.7 cm) H

Shock & Vibration: EN 300 019-2-4, IEC 60068

Water Ingress: IPx5



PN18-5900PM

Directional Panel Antenna

Frequency: 5850-5925 MHz

Gain: 18 dBi

Dimensions: 5.8" (146mm) x 5.8" (146mm)

Shock & Vibration: EN 61373, IEEE 147, MIL-810G

Water Ingress: IPx5



PS11-5900-90

Panel Sector Antenna

Frequency: 5850 - 5925 MHz

Gain: 11 dB

Dimensions: 12.5" (32cm) H x 3" (7.6cm) W

Beamwidth: 60° Az, 12° El



YAG12-5900

Yagi Directional Antenna

Frequency: 5850 - 5925 MHz

Gain: 12 dBi

Dimensions: 2.75" (7cm) H x 6.35" (16cm) L x 0.56" (1.4cm) W

Shock & Vibration: EN 300 019-2-4, IEC 60068

Water Ingress: IPx5

These antennas contain either a GPS antenna or a multi-system GNSS Global Navigation antenna covering GPS, Glonass and Galileo. In addition, most of the antennas in the GNSS & Multiband section contain additional elements to provide coverage on frequency bands such as Cellular LTE, WiFi, DSRC, or UHF.



IWG-1575

GNSS Glass Mount Antenna

Frequency: 1561, 1575 & 1602 MHz

Gain: 5dBi

Dimensions: 7/8" (22mm) L x 1 5/8" (41mm) W x 1 5/8" (41mm) H

Water Ingress: IPx5

*Specify **IW-1575** for GPS only model



MAG-NAV

Magnet Mount Antenna

Frequency: 1561, 1575 & 1602 MHz

Gain: 5dBi

Dimensions: 1.75" (4.5cm) W x 2.0" (5cm) L x .56" (1.5cm) H

Water Ingress: IPx5

*Specify **MAG-1575** for GPS only model

*Also available in white



SMG-1575

GNSS Surface Mount Antenna

Frequency: 1561, 1575 & 1602 MHz

Gain: 5 dBi

Dimensions: 1.75" (6.4cm) W x 2.0" (5.1cm) L x .56" (14mm) H

Shock and Vibration: EN 61373, IEEE 1478, MIL-80G, TIA-329.2-C

Water Ingress: IPx5



NTG-1575

GNSS Timing Antenna

Frequency: 1561, 1575 & 1602 MHz

Gain: 5 dBi

Dimensions: 3/4" (1.9cm) D x 1/2" (1.3cm) H

Shock and Vibration: EN 300 0019-2-4, IEC 60068

Water Ingress: IP67

*Specify **NT-1575** for GPS only model



CVWG-LTE (LTE & GNSS)

Covert Broadband Antenna

Cable 1: 694 - 960 & 2100 - 2700 MHz, 2.5 dBi

Cable 2: 1561, 1575 & 1602 MHz, 5 dBi

Dimensions: 5 1/2" (14cm) L x 1 1/2" (4cm) W

Shock and Vibration: IEEE1478, EN61373, MIL-810G, TIA 329.2-C

Water Ingress: IPx7

*Specify **CVW-LTE** for GPS only model



CVWG-UMB (Cellular & GNSS)

Covert Cellular Antenna

Cable 1: 800 - 960 & 1700 - 2200 MHz, 2.5 dBi

Cable 2: 1561, 1575 & 1602 MHz, 5 dBi

Dimensions: 5 1/2" (14cm) L x 1 1/2" (4cm) W

Shock and Vibration: IEEE1478, EN61373, MIL-810G, TIA 329.2-C

Water Ingress: IPx7

*Specify **CVW-UMB** for GPS only model



LMWG-201 (LTE & GNSS)

Low Profile LTE Antenna

Cable 1: 695 - 960 MHz (Unity) & 1700 - 2700 MHz, 3 dBi

Cable 2: 1561, 1575 & 1602 MHz, 5 dBi

Dimensions: 3.5" (8.9cm) D x 1.5" (3.8cm) H

Shock and Vibration: IEEE1478, EN61373, MIL-810G

Water Ingress: IP67

*Specify **LMW-201** for GPS only model

*Also available in black



LMWG-202 (LTE/CBRS & GNSS)

Low Profile Wideband LTE Antenna

Cable 1: 695 - 960 MHz (Unity) & 1700 - 3700 MHz, 3 dBi

Cable 2: 1561, 1575 & 1602 MHz, 5 dBi

Dimensions: 3.5" (8.9cm) D x 1.5" (3.8cm) H

Shock and Vibration: IEEE1478, EN61373, MIL-810G

Water Ingress: IP67

*Specify **LMW-202** for GPS only model

*Also available in black



LMWG-203 (Wideband 6 GHz & GNSS)

Low Profile Super Wideband LTE Antenna

Cable 1: 694 - 960 MHz, Unity & 1710 - 6000 MHz, 3 dBi

Cable 2: 1561, 1575 & 1602 MHz, 5 dBi

Dimensions: 3.5" (8.9cm) D x 1.5" (3.8cm) H

Shock and Vibration: IEEE1478, EN61373, MIL-810G

Water Ingress: IP67



LMWG-UMB (LTE & GNSS)

Low Profile Cellular Antenna

Cable 1: 800 - 1250 MHz, Unity & 1650 - 2200 MHz, 4 dBi

Cable 2: 1561, 1575 & 1602 MHz, 5 dBi

Dimensions: 3.5" (8.9cm) D x 1.5" (3.8cm) H

Shock and Vibration: IEEE1478, EN61373, MIL-810G

Water Ingress: IP67

*Specify **LMW-UMB** for GPS only model

*Also available in black



LLPG203 (Global LTE & GNSS)

Low Profile Cellular Antenna

Cable 1: 694 - 960 MHz, 0 - 3 dBi & 1710 - 3700 MHz, 4 dBi

Cable 2: 1561, 1575 & 1602 MHz, 5 dBi

Dimensions: 9" (22.8cm) L x 3.5" (8.9cm) W x 1.5" (3.8cm) H

Shock and Vibration: IEEE1478, EN61373, MIL-810G

Water Ingress: IP67

*Specify **MLPG203** for mag-mount

*Specify **LLP203** (or **MLP203**) for GPS only Model

*Also available in White



DMG-W15 (WiFi & GNSS)

Surface Mount Dome Antenna

Cable 1: 2.4 - 2.5 & 4.9 - 6.0 MHz, 2.5 dBi

Cable 2: 1561, 1575 & 1602 MHz, 5 dBi

Dimensions: 2.85" (7.2cm) D x 1.45" (3.7cm) H

Shock and Vibration: IEEE1478, EN61373, MIL-810G, TIA 329.2-C

Water Ingress: IPx7

*Specify **MGDG-W15** for mag-mount

*Specify **DM-W15** (or **MGD-W15**) for GPS only model

*Also available in black



SMG-E15 (EU Cellular & GNSS)

Cellular & GNSS Combination Surface Mount Antenna

Cable 1: 870 - 960 & 1710 - 1880 MHz, unity gain

Cable 2: 1561, 1575 & 1602, 5 dBi

Dimensions: 4.5" (114mm) D x .95" (24mm) H

Shock and Vibration: IEEE1478, EN61373, MIL-810G, TIA 329.2-C

Water Ingress: IPx5

*Specify **SM-E15** for GPS only model

*Also available in black



SMG-U15 (US Cellular & GNSS)

Cellular & GNSS Combination Surface Mount Antenna

Cable 1: 824 - 894 & 1850 - 1990 MHz (unity gain)

Cable 2: 1561, 1575 & 1602, 5 dBi

Dimensions: 4.5" (114mm) D x .95" (24mm) H

Shock and Vibration: IEEE1478, EN61373, MIL-810G, TIA 329.2-C

Water Ingress: IPx5

*Specify **SM-U15** for GPS only model

*Also available in black



SMVG-UCE (Cellular & GNSS)

Cellular & GNSS Combination Antenna

Cable 1: 806 - 960 MHz, 2 dBi & 1710 - 1990 MHz, unity gain

Cable 2: 1561, 1575 & 1602 MHz, 5 dBi

Dimensions: 5" (12.7cm) H, Base: 1" (2.5cm) H x 2 5/8" (6.7cm) D

Shock and Vibration: IEEE1478, EN61373, MIL-810G, TIA 329.2-C

Water Ingress: IPx5

*Specify **SMV-UCE** for GPS only model



LLPG302 (2xGlobal LTE & GNSS) Low Profile Cellular Antenna

Cables 1 & 2: 694 - 960 MHz, 0 - 3 dBi & 1710 - 3700 MHz, 4 dBi

Cable 3: 1561, 1575 & 1602 MHz, 5 dBi

Dimensions: 9" (22.8cm) L x 3.5" (8.9cm) W x 1.5" (3.8cm) H

Shock and Vibration: IEEE1478, EN61373, MIL-810G, TIA 329.2-C

Water Ingress: IP67

*Specify **MLPG302** for mag-mount

*Specify **LLP302** (or **MLP302**) for GPS only Model

*Also available in White



LLPG304 (Global LTE, UHF & GNSS) Low Profile UHF Antenna

Cable 1: 694 - 960 MHz, 0 - 3 dBi & 1710 - 4200 MHz, 4 dBi

Cable 2: 450 - 470 MHz, 3 dBi

Cable 3: 1561, 1575 & 1602 MHz, 5 dBi

Dimensions: 9" (22.8cm) L x 3.5" (8.9cm) W x 1.5" (3.8cm) H

Water Ingress: IP67

*Specify **LLP304** for GPS only Model

*Also available in White



LTBG301 (2xLTE & GNSS) Multiband 4G/LTE 2x MiMO Antenna

Cables 1 & 2: 694 - 960 MHz, 3 dBi & 1710 - 2700 MHz 4 dBi

Cable 3: 1561, 1575 & 1602 MHz, 5 dBi

Dimensions: 3.68" (98.5cm) H x 7.49" (190.2cm) W x 1.50" (38.1cm) D

Shock and Vibration: EN 300 019-2-4, IEC 60068, SAE J1455

Water Ingress: IP67

*Specify **LTB301** for GPS only model



LTBG302 (2xGlobal LTE & GNSS) Multiband 5G Ready 2x MiMO Antenna

Cables 1 & 2: 694 - 960 MHz, 3 dBi & 1710 - 4200 MHz 4 dBi

Cable 3: 1561, 1575 & 1602 MHz, 5 dBi

Dimensions: 3.68" (98.5cm) H x 7.49" (190.2cm) L x 1.50" (38.1cm) W

Shock and Vibration: EN 300 019-2-4, IEC 60068, SAE J1455

Water Ingress: IP67

*Specify **LTB302** for GPS only model



LTMG301 (2xLTE & GNSS)

GNSS Multiband Surface Mount Antenna

Cables 1 & 2: 694 - 960 MHz, 3 dBi & 1710 - 2170 MHz 4 dBi

Cable 3: 1561, 1575 & 1602 MHz, 5 dBi

Dimensions: 5.50" (14cm) D x 2.38" (6.04cm) H

Shock and Vibration: IEEE1478, EN61373, MIL-810G, TIA 329.2-C

Water Ingress: IP67

*Specify **MLTMG301** for mag-mount model

*Specify **LTM301** (or **MLTM301**) for GPS only model

*Also available in black



LTMG302 (2xGlobal LTE & GNSS)

GNSS Multiband Surface Mount Antenna

Cables 1 & 2: 694 - 960 MHz, 3 dBi & 1710 - 3700 MHz 4 dBi

Cable 3: 1561, 1575 & 1602 MHz, 5 dBi

Dimensions: 5.50" (14cm) D x 2.38" (6.04cm) H

Shock and Vibration: IEEE1478, EN61373, MIL-810G, TIA 329.2-C

Water Ingress: IP67

*Specify **MLTMG302** for mag-mount model

*Specify **LTM302** (or **MLTM302**) for GPS only model

*Also available in white



SMWG-301 (LTE, WiFi & GNSS)

GNSS Multiband Surface Mount Antenna

Cable 1: 800 - 1250 MHz, 3 dBi & 1650 - 2700 MHz, 5 dBi

Cable 2: 2.4 - 2.5 & 4.9 - 6.0 GHz, 5 dBi

Cable 3: 1561, 1575 & 1602 MHz, 5 dBi

Dimensions: 4.2" (10.7cm) D x 3.2" (8.1cm) H

Shock and Vibration: IEEE1478, EN61373, MIL-810G, TIA 329.2-C

Water Ingress: IP67

*Specify **MGWG-301** for mag-mount model

*Specify **SMW-301** (or **MGW-301**) for GPS only model

*Also available in black



SMWG-302 (LTE, AWS & GNSS) GNSS Multiband Surface Mount Antenna

Cable 1: 800 - 1250 MHz, 3 dBi & 1650 - 2700 MHz, 5 dBi

Cable 2: 1.7 - 2.7 GHz, 5 dBi

Cable 3: 1561, 1575 & 1602 MHz, 5 dBi

Dimensions: 4.2" (10.7cm) D x 3.2" (8.1cm) H

Shock and Vibration: IEEE1478, EN61373, MIL-810G, TIA 329.2-C

Water Ingress: IP67

*Specify **MGWG-302** for mag-mount model

*Specify **SMW-302** (or **MGW-302**) for GPS only model

*Also available in black



SMWG-303 (2xWiFi & GNSS) GNSS Multiband Surface Mount Antenna

Cable 1: 2.4 - 2.5 & 4.9 - 6.0 GHz, 5 dBi

Cable 2: 2.1 - 2.5 & 4.4 - 6.0 GHz, 5 dBi

Cable 3: 1561, 1575 & 1602 MHz, 5 dBi

Dimensions: 4.2" (10.7cm) D x 3.2" (8.1cm) H

Shock and Vibration: IEEE1478, EN61373, MIL-810G, TIA 329.2-C

Water Ingress: IP67

*Specify **MGWG-303** for mag-mount model

*Specify **SMW-303** (or **MGW-303**) for GPS only model

*Also available in black



SMWG-304 (2xWiFi & GNSS) GNSS Multiband Surface Mount Antenna

Cable 1: 2.4 - 2.5 GHz, 5 dBi

Cable 2: 2.1 - 2.5 & 4.9 - 6.0 GHz, 5 dBi

Cable 3: 1561, 1575 & 1602 MHz, 5 dBi

Dimensions: 4.2" (10.7cm) D x 3.2" (8.1cm) H

Shock and Vibration: IEEE1478, EN61373, MIL-810G, TIA 329.2-C

Water Ingress: IP67

*Specify **MGWG-304** for mag-mount model

*Specify **SMW-304** (or **MGW-304**) for GPS only model

*Also available in black



SMWG-305 (LTE, WiFi & GNSS) GNSS Multiband Surface Mount Antenna

Cable 1: 694 - 894 MHz, 3 dBi & 1.7 - 2.7 GHz, 5 dBi

Cable 2: 2.4 - 2.5 & 4.9 - 6.0 GHz, 5 dBi

Cable 3: 1561, 1575 & 1602 MHz, 5 dBi

Dimensions: 4.2" (10.7cm) D x 3.2" (8.1cm) H

Shock and Vibration: IEEE1478, EN61373, MIL-810G, TIA 329.2-C

Water Ingress: IP67

*Specify **MGWG-305** for mag-mount model

*Specify **SMW-305** (or **MGW-305**) for GPS only model

*Also available in black



SMWG-306 (WiFi, CBRS & GNSS) GNSS Multiband Surface Mount Antenna

Cable 1: 2.4 - 2.5 GHz, 5 dBi

Cable 2: 3.0 - 6.0 GHz, 5 dBi

Cable 3: 1561, 1575 & 1602 MHz, 5 dBi

Dimensions: 4.2" (10.7cm) D x 3.2" (8.1cm) H

Shock and Vibration: IEEE1478, EN61373, MIL-810G, TIA 329.2-C

Water Ingress: IP67

*Specify **MGWG-306** for mag-mount model

*Specify **SMW-306** (or **MGW-306**) for GPS only model

*Also available in black



SMWG-310 (UHF, WiFi & GNSS) GNSS Multiband UHF Surface Mount Antenna

Cable 1: 450 - 470 MHz, 2 dBi

Cable 2: 2.4 - 2.5 & 4.9 - 6.0 GHz, 5 dBi

Cable 3: 1561, 1575 & 1602 MHz, 5 dBi

Dimensions: 4.2" (10.7cm) D x 3.2" (8.1cm) H

Shock and Vibration: IEEE1478, EN61373, MIL-810G, TIA 329.2-C

Water Ingress: IP67

*Specify **SMW-310** for GPS only model

*Also available in black



SMWG-311 (Global LTE, WiFi & GNSS) GNSS Multiband Surface Mount Antenna

Cable 1: 694 - 960 MHz, 3 dBi, 1.7 - 3.7 GHz, 4 dBi

Cable 2: 2.4 - 2.5 & 4.9 - 6.0 GHz, 5 dBi

Cable 3: 1561, 1575 & 1602 MHz, 5 dBi

Dimensions: 4.2" (10.7cm) D x 3.2" (8.1cm) H

Shock and Vibration: IEEE1478, EN61373, MIL-810G, TIA 329.2-C

Water Ingress: IP67

*Specify **MGWG-311** for mag-mount model

*Specify **SMW-311** (or **MGW-311**) for GPS only model

*Also available in black



SMWG-312 (Wideband 6 GHz, WiFi & GNSS) GNSS Multiband Surface Mount Antenna

Cable 1: 694 - 960 MHz, 3 dBi & 1710 - 6000 MHz, 5 dBi

Cable 2: 2.4 - 2.5 & 4.9 - 6.0 GHz, 5 dBi

Cable 3: 1561, 1575 & 1602 MHz, 5 dBi

Dimensions: 4.2" (10.7cm) D x 3.2" (8.1cm) H

Shock and Vibration: IEEE1478, EN61373, MIL-810G, TIA 329.2-C

Water Ingress: IP67

*Specify **MGWG-312** for mag-mount model

*Specify **SMW-312** (or **MGW-312**) for GPS only model

*Also available in black



SMWG-313 (2xDSRC & GNSS) GNSS Multiband DSRC/C-V2X Surface Mount Antenna

Cables 1 & 2: 5800 - 6000 MHz, 7 dBi

Cable 3: 1561, 1575 & 1602 MHz, 5 dBi

Dimensions: 4.2" (10.7cm) D x 3.2" (8.1cm) H

Shock and Vibration: IEEE1478, EN61373, MIL-810G, TIA 329.2-C

Water Ingress: IP67

*Specify **MGWG-313** for mag-mount model

*Specify **SMW-313** (or **MGW-313**) for GPS only model

*Also available in black



SMWG-314 (Global LTE, DSRC & GNSS) GNSS Multiband DSRC/C-V2X Surface Mount Antenna

Cable 1: 694 - 894 MHz, 3 dBi & 1710 - 3700 MHz, 4 dBi

Cable 2: 5800 - 6000 MHz, 7 dBi

Cable 3: 1561, 1575 & 1602 MHz, 5 dBi

Dimensions: 4.2" (10.7cm) D x 3.2" (8.1cm) H

Shock and Vibration: IEEE1478, EN61373, MIL-810G, TIA 329.2-C

Water Ingress: IP67

*Specify **MGWG-314** for mag-mount model

*Specify **SMW-314** (or **MGW-314**) for GPS only model

*Also available in black



SMWG-UMB (Cellular, WiFi & GNSS) GNSS Multiband Surface Mount Antenna

Cable 1: 800 - 1250 MHz, 3 dBi & 1650 - 2700 MHz, 5 dBi

Cable 2: 2.0 - 2.5 GHz, 5 dBi

Cable 3: 1561, 1575 & 1602 MHz, 5 dBi

Dimensions: 4.2" (10.7cm) D x 3.2" (8.1cm) H

Shock and Vibration: IEEE1478, EN61373, MIL-810G, TIA 329.2-C

Water Ingress: IP67

*Specify **MGWG-UMB** for mag-mount model

*Specify **SMW-UMB** (or **MGW-UMB**) for GPS only model

*Also available in black



MXFG302 (Global LTE, WiFi & GNSS) Multiband Diversity/MIMO Antenna

Cable 1: 694 - 960 MHz, 3 dBi & 1710 - 3700 MHz 4 dBi

Cable 2: 2.4 - 2.5 & 4.9 - 6.0 GHz, 5 dBi

Cable 3: 1561, 1575 & 1602 MHz, 5 dBi

Dimensions: 7.5" (19cm) x 2.25" (5.7cm) x 2.5" (6.4cm)

*Specify **MMXFG302** for mag-mount

*Specify **MXF302** (or **MMXF302**) for GPS only model



CVWG402 (2xLTE, WiFi & GNSS) Covert Multiband Antenna

Cables 1 & 2: 694 - 960 MHz, 3 dBi & 1710 - 2750 MHz, 4 dBi

Cable 3: 2.4 - 2.5 & 4.9 - 6.0 GHz, 5 dBi

Cable 4: 1561, 1575 & 1602 MHz, 5 dBi

Dimensions: 7" (17.8cm) L x 2" (5.1cm) W x 3/4" (1.9cm) H

Shock and Vibration: IEEE1478, EN61373

Water Ingress: IP67

*Specify **CVW402** for GPS only model



LLPG402 (2xGlobal LTE, WiFi & GNSS) Low Profile Global LTE & Multiband Antenna

Cables 1 & 2: 694 - 960 MHz, 0 - 3 dBi & 1710 - 3700 MHz, 4 dBi

Cable 3: 2.4 - 2.5 GHz, 4 dBi & 5.0 - 6.0 MHz, 5 dBi

Cable 4: 1561, 1575 & 1602 MHz, 5 dBi

Dimensions: 9" (22.8cm) L x 3.5" (8.9cm) W x 1.5" (3.8cm) H

Shock and Vibration: IEEE1478, EN61373, MIL-810G, TIA 329.2-C

Water Ingress: IP67

*Specify **MLPG402** for mag-mount

*Specify **LLP402** (or **MLP402**) for GPS only Model

*Also available in black



LLPG403 (Global LTE, 2xWiFi & GNSS) Low Profile Global LTE & Multiband Antenna

Cable 1: 694 - 960 MHz, 0 - 3 dBi & 1710 - 3700 MHz, 4 dBi

Cables 2 & 3: 2.4 - 2.5 GHz, 4 dBi & 5.0 - 6.0 MHz, 5 dBi

Cable 4: 1561, 1575 & 1602 MHz, 5 dBi

Dimensions: 9" (22.8cm) L x 3.5" (8.9cm) W x 1.5" (3.8cm) H

Shock and Vibration: IEEE1478, EN61373, MIL-810G, TIA 329.2-C

Water Ingress: IP67

*Specify **MLPG403** for mag-mount

*Specify **LLP403** (or **MLP403**) for GPS only Model

*Also available in black



LTMG401 (2xLTE, WiFi & GNSS)

GNSS Multiband Surface Mount Antenna

Cables 1 & 2: 694 - 960 MHz, 3 dBi & 1710 - 2170 MHz 4 dBi

Cable 3: 2.4 - 2.5 & 4.9 - 6.0 GHz, 5 dBi

Cable 4: 1561, 1575 & 1602 MHz, 5 dBi

Dimensions: 5.50" (14cm) D x 2.38" (6.04cm) H

Shock and Vibration: IEEE1478, EN61373, MIL-810G, TIA 329.2-C

Water Ingress: IP67

*Specify **MLTMG401** for mag-mount model

*Specify **LTM401** (or **MLTM401**) for GPS only model

*Also available in black



LTMG402 (2xGlobal LTE, WiFi & GNSS)

GNSS Multiband Surface Mount Antenna

Cables 1 & 2: 694 - 960 MHz, 3 dBi & 1710 - 3700 MHz 4 dBi

Cable 3: 2.4 - 2.5 & 4.9 - 6.0 GHz, 5 dBi

Cable 4: 1561, 1575 & 1602 MHz, 5 dBi

Dimensions: 5.50" (14cm) D x 2.38" (6.04cm) H

Shock and Vibration: IEEE1478, EN61373, MIL-810G, TIA 329.2-C

Water Ingress: IP67

*Specify **MLTMG402** for mag-mount model

*Specify **LTM402** (or **MLTM402**) for GPS only model

*Also available in white



SMWG-402 (LTE, WiFi 2.4, WiFi 2.4/5 & GNSS)

GNSS Multiband Surface Mount Antenna

Cable 1: 800 - 1250 MHz, 3 dBi & 1650 - 2700 MHz, 5 dBi

Cable 2: 2.4 - 2.5 GHz, 5 dBi

Cable 3: 2.1 - 2.5 & 4.9 - 6.0 GHz, 5 dBi

Cable 4: 1561, 1575 & 1602 MHz, 5 dBi

Dimensions: 4.2" (10.7cm) D x 3.2" (8.1cm) H

Shock and Vibration: IEEE1478, EN61373, MIL-810G, TIA 329.2-C

Water Ingress: IP67

*Specify **MGWG-402** for mag-mount model

*Specify **SMW-402** (or **MGW-402**) for GPS only model

*Also available in white



SMWG-404 (Cellular, 2xWiFi & GNSS) GNSS Multiband Surface Mount Antenna

Cable 1: 800 - 1250 MHz, 3 dBi & 1650 - 2700 MHz, 5 dBi

Cable 2: 2.4 - 2.5 & 4.9 - 6.0 GHz, 5 dBi

Cable 3: 2.1 - 2.5 & 4.4 - 6.0 GHz, 5 dBi

Cable 4: 1561, 1575 & 1602 MHz, 5 dBi

Dimensions: 4.2" (10.7cm) D x 3.2" (8.1cm) H

Shock and Vibration: IEEE1478, EN61373, MIL-810G, TIA 329.2-C

Water Ingress: IP67

*Specify **MGWG-402** for mag-mount model

*Specify **SMW-402** (or **MGW-402**) for GPS only model

*Also available in white



SMWG-405 (Cellular, WiFi & 2xGNSS) GNSS Multiband Surface Mount Antenna

Cable 1: 800 - 1250 MHz, 3 dBi, 1650 - 2700 MHz, 5 dBi

Cable 2: 2.4 - 2.5 & 4.9 - 6.0 GHz, 5 dBi

Cable 3: 1561, 1575 & 1602 MHz, 5 dBi

Cable 4: 1561, 1575 & 1602 MHz, 5 dBi

Dimensions: 4.2" (10.7cm) D x 3.2" (8.1cm) H

Shock and Vibration: IEEE1478, EN61373, MIL-810G, TIA 329.2-C

Water Ingress: IP67

*Specify **MGWG-405** for mag-mount model

*Specify **SMW-405** (or **MGW-405**) for GPS only model

*Also available in white



SMWG-406 (Cellular, AWS, WiFi & GNSS) GNSS Multiband Surface Mount Antenna

Cable 1: 800 - 1250 MHz, 3 dBi, 1650 - 2700 MHz, 5 dBi

Cable 2: 1.7 - 2.7 GHz, 5 dBi

Cable 3: 2.4 - 2.5 & 4.4 - 6.0 GHz, 5 dBi

Cable 4: 1561, 1575 & 1602 MHz, 5 dBi

Dimensions: 4.2" (10.7cm) D x 3.2" (8.1cm) H

Shock and Vibration: IEEE1478, EN61373, MIL-810G, TIA 329.2-C

Water Ingress: IP67

*Specify **MGWG-406** for mag-mount model

*Specify **SMW-406** (or **MGW-406**) for GPS only model

*Also available in white



SMWG-410 (3xWiFi & GNSS)

GNSS Multiband Surface Mount Antenna

Cable 1: 2.1 - 2.5 & 4.4 - 6.0 GHz, 5 dBi

Cable 2: 2.4 - 2.5 & 4.9 - 6.0 GHz, 5 dBi

Cable 3: 2.4 - 2.5 & 4.9 - 6.0 GHz, 5 dBi

Cable 4: 1561, 1575 & 1602 MHz, 5 dBi

Dimensions: 4.2" (10.7cm) D x 3.2" (8.1cm) H

Shock and Vibration: IEEE1478, EN61373, MIL-810G, TIA 329.2-C

Water Ingress: IP67

*Specify **MGWG-410** for mag-mount model

*Specify **SMW-410** (or **MGW-410**) for GPS only model

*Also available in white



SMWG-412 (LTE, 2xWiFi & GNSS)

GNSS Multiband Surface Mount Antenna

Cable 1: 694 - 894 MHz, 3 dBi & 1.7 - 2.7 GHz, 5 dBi

Cable 2: 2.4 - 2.5 & 4.9 - 6.0 GHz, 5 dBi

Cable 3: 2.1 - 2.5 & 4.4 - 6.0 GHz, 5 dBi

Cable 4: 1561, 1575 & 1602 MHz, 5 dBi

Dimensions: 4.2" (10.7cm) D x 3.2" (8.1cm) H

Shock and Vibration: IEEE1478, EN61373, MIL-810G, TIA 329.2-C

Water Ingress: IP67

*Specify **MGWG-412** for mag-mount model

*Specify **SMW-412** (or **MGW-412**) for GPS only model

*Also available in white



SMWG-413 (LTE, 2xAWS & GNSS)

GNSS Multiband Surface Mount Antenna

Cable 1: 694 - 894 MHz, 3 dBi & 1.7 - 2.7 GHz, 5 dBi

Cables 2 & 3: 1.7 - 2.7 GHz, 5 dBi

Cable 4: 1561, 1575 & 1602 MHz, 5 dBi

Dimensions: 4.2" (10.7cm) D x 3.2" (8.1cm) H

Shock and Vibration: IEEE1478, EN61373, MIL-810G, TIA 329.2-C

Water Ingress: IP67

*Specify **MGWG-413** for mag-mount model

*Specify **SMW-413** (or **MGW-413**) for GPS only model

*Also available in white



SMWG-414 (Global LTE, 2xWiFi & GNSS) GNSS Multiband Surface Mount Antenna

Cable 1: 694 - 894 MHz, 3 dBi & 1.7 - 3.7 GHz, 5 dBi

Cable 2: 2.4 - 2.5 & 4.9 - 6.0 GHz, 5 dBi

Cable 3: 2.1 - 2.5 & 4.4 - 6.0 GHz, 5 dBi

Cable 4: 1561, 1575 & 1602 MHz, 5 dBi

Dimensions: 4.2" (10.7cm) D x 3.2" (8.1cm) H

Shock and Vibration: IEEE1478, EN61373, MIL-810G, TIA 329.2-C

Water Ingress: IP67

*Specify **MGWG-414** for mag-mount model

*Specify **SMW-414** (or **MGW-414**) for GPS only model

*Also available in white



SMWG-415 (LTE, WiFi & 2xGNSS) GNSS Multiband Surface Mount Antenna

Cable 1: 694 - 960 MHz, 3 dBi, 1650 - 2700 MHz, 5 dBi

Cable 2: 2.4 - 2.5 & 4.9 - 6.0 GHz, 5 dBi

Cable 3: 1561, 1575 & 1602 MHz, 5 dBi

Cable 4: 1561, 1575 & 1602 MHz, 5 dBi

Dimensions: 4.2" (10.7cm) D x 3.2" (8.1cm) H

Shock and Vibration: IEEE1478, EN61373, MIL-810G, TIA 329.2-C

Water Ingress: IP67

*Specify **MGWG-415** for mag-mount model

*Specify **SMW-415** (or **MGW-415**) for GPS only model

*Also available in white



MXFG402 (2xGlobal LTE, WiFi & GNSS) Multiband Diversity/MIMO Antenna

Cables 1 & 2: 694 - 960 MHz, 3 dBi & 1710 - 3700 MHz 4 dBi

Cable 3: 2.4 - 2.5 & 4.9 - 6.0 GHz, 5 dBi

Cable 4: 1561, 1575 & 1602 MHz, 5 dBi

Dimensions: 7.5" (19cm) L x 2.25" (5.7cm) W x 2.5" (6.4cm) H

*Specify **MMXFG402** for mag-mount

*Specify **MXF402** (or **MMXF402**) for GPS only model



CVWG502 (2xLTE, 2xWiFi & GNSS) GNSS Multiband Surface Mount Antenna

Cables 1 & 2: 694 - 894 MHz, 3 dBi & 1710 - 2750 MHz, 4 dBi

Cables 3 & 4: 2.4 - 2.5 & 4.9 - 6.0 GHz, 5 dBi

Cable 5: 1561, 1575 & 1602 MHz, 5 dBi

Dimensions: 7" (17.8cm) L x 2" (5.1cm) W x 3/4" (1.9cm) H

Shock and Vibration: IEEE1478, EN61373

Water Ingress: IP67

*Specify **CVW502** for GPS only model



LLPG502 (2xGlobal LTE, 2xWiFi & GNSS) Low Profile Cellular Antenna

Cables 1 & 2: 694 - 960 MHz, 0 - 3 dBi & 1710 - 3700 MHz, 4 dBi

Cables 3 & 4: 2.4 - 2.5 GHz, 4 dBi & 5.0 - 6.0 MHz, 5 dBi

Cable 5: 1561, 1575 & 1602 MHz, 5 dBi

Dimensions: 9" (22.8cm) L x 3.5" (8.9cm) W x 1.5" (3.8cm) H

Shock and Vibration: IEEE1478, EN61373, MIL-810G, TIA 329.2-C

Water Ingress: IP67

*Specify **MLPG502** for mag-mount

*Specify **LLP502** (or **MLP502**) for GPS only Model

*Also available in Black



LTMG501 (2xLTE, 2xWiFi & GNSS) GNSS Multiband Surface Mount Antenna

Cables 1 & 2: 694 - 960 MHz, 3 dBi & 1710 - 2170 MHz 4 dBi

Cables 3 & 4: 2.4 - 2.5 & 4.9 - 6.0 GHz, 5 dBi

Cable 5: 1561, 1575 & 1602 MHz, 5 dBi

Dimensions: 5.50" (14cm) D x 2.38" (6.04cm) H

Shock and Vibration: IEEE1478, EN61373, MIL-810G, TIA 329.2-C

Water Ingress: IP67

*Specify **MLTMG501** for mag-mount model

*Specify **LTM501** (or **MLTM501**) for GPS only model

*Also available in white



LTMG502 (2xGlobal LTE, 2xWiFi & GNSS) GNSS Multiband Surface Mount Antenna

Cables 1 & 2: 694 - 960 MHz, 3 dBi & 1710 - 3700 MHz, 4 dBi

Cables 3 & 4: 2.4 - 2.5 & 4.9 - 6.0 GHz, 5 dBi

Cable 5: 1561, 1575 & 1602 MHz, 5 dBi

Dimensions: 5.50" (14cm) D x 2.38" (6.04cm) H

Shock and Vibration: IEEE1478, EN61373, MIL-810G, TIA 329.2-C

Water Ingress: IP67

*Specify **MLTMG502** for mag-mount model

*Specify **LTM502** (or **MLTM502**) for GPS only model

*Also available in white



LTMG504 (4xWiFi & GNSS) GNSS Multiband Surface Mount Antenna

Cables 1 - 4: 2.4 - 2.5 & 4.9 - 6.0 GHz, 5 dBi

Cable 5: 1561, 1575 & 1602 MHz, 5 dBi

Dimensions: 5.50" (14cm) D x 2.38" (6.04cm) H

Shock and Vibration: IEEE1478, EN61373, MIL-810G, TIA 329.2-C

Water Ingress: IP67

*Specify **MLTMG504** for mag-mount model

*Specify **LTM504** (or **MLTM504**) for GPS only model

*Also available in white



LTMG505 (LTE, 3xWiFi & GNSS) GNSS Multiband Surface Mount Antenna

Cable 1: 694 - 960 MHz, 3 dBi & 1710 - 2170 MHz 4 dBi

Cables 2-4: 2.4 - 2.5 & 4.9 - 6.0 GHz, 5 dBi

Cable 5: 1561, 1575 & 1602 MHz, 5 dBi

Dimensions: 5.50" (14cm) D x 2.38" (6.04cm) H

Shock and Vibration: IEEE1478, EN61373, MIL-810G, TIA 329.2-C

Water Ingress: IP67

*Specify **MLTMG505** for mag-mount model

*Specify **LTM505** (or **MLTM505**) for GPS only model

*Also available in white



LTMG506 (2xLTE, 2xCBRS & GNSS) Multiband Diversity/MIMO Antenna

Cables 1 & 2: 694 - 960 MHz, 3 dBi & 1710 - 2170 MHz 4 dBi

Cables 3 & 4: 3300 - 3800 MHz, 5 dBi

Cable 5: 1561, 1575 & 1602 MHz, 5 dBi

Dimensions: 5.50" (14cm) D x 2.38" (6.04cm) H

Shock and Vibration: IEEE1478, EN61373, MIL-810G, TIA 329.2-C

Water Ingress: IP67

*Specify **MLTMG506** for mag-mount model

*Specify **LTM506** (or **MLTM506**) for GPS only model

*Also available in white



LTMG508 (2x5G LTE, 2xWiFi & GNSS) Sub-6 5G Ready Diversity/MIMO Antenna

Cables 1 & 2: 600 - 960 MHz, 3 dBi & 1710 - 6000 MHz 4 dBi

Cables 3 & 4: 2.4 - 2.5 & 4.9 - 6.0 GHz, 5 dBi

Cable 5: 1561, 1575 & 1602 MHz, 5 dBi

Dimensions: 5.50" (14cm) D x 2.38" (6.04cm) H

Shock and Vibration: IEEE1478, EN61373, MIL-810G, TIA 329.2-C

Water Ingress: IP67

*Specify **MLTMG508** for mag-mount model

*Specify **LTM508** (or **MLTM508**) for GPS only model

*Also available in white



LTMG940 (4xLTE, 0xWiFi & GNSS) Multiband Diversity/MIMO Antenna

Cables 1 - 4: 694 - 960 MHz, 3 dBi & 1710 - 3700 MHz 5 dBi

Cable 5: 1561, 1575 & 1602 MHz, 5 dBi

Dimensions: 5.50" (14cm) D x 2.38" (6.04cm) H

Shock and Vibration: IEEE1478, EN61373

Water Ingress: IP67

*Specify **LTM940** for GPS only model

*Also available in white

*Not available as a mag-mount



MXFG502 (2x Global LTE, 2xWiFi & GNSS) Multiband Diversity/MIMO Antenna

Cables 1 & 2: 694 - 960 MHz, 3 dBi & 1710 - 3700 MHz 4 dBi

Cables 3 & 4: 2.4 - 2.5 & 4.9 - 6.0 GHz, 5 dBi

Cable 5: 1561, 1575 & 1602 MHz, 5 dBi

Dimensions: 7.5" (19cm) L x 2.25" (5.7cm) W x 2.5" (6.4cm) H

*Specify **MMXFG502** for mag-mount

*Specify **MXF502** (or **MMX502**) for GPS only model



LLPG602 (2xGlobal LTE, 3xWiFi & GNSS) Low Profile Global LTE Antenna

Cables 1 & 2: 694 - 960 MHz, 0 - 3 dBi & 1710 - 3700 MHz, 4 dBi

Cables 3 - 5: 2.4 - 2.5 GHz, 4 dBi & 5.0 - 6.0 MHz, 5 dBi

Cable 6: 1561, 1575 & 1602 MHz, 5 dBi

Dimensions: 9" (22.8cm) L x 3.5" (8.9cm) W x 1.5" (3.8cm) H

Shock and Vibration: IEEE1478, EN61373, MIL-810G, TIA 329.2-C

Water Ingress: IP67

*Specify **MLPG602** for mag-mount

*Specify **LLP602** (or **MLP602**) for GPS only Model

*Also available in Black



LTMG601 (2xLTE, 3xWiFi & GNSS) Multiband Diversity/MIMO Antenna

Cables 1 & 2: 694 - 960 MHz, 3 dBi & 1710 - 2170 MHz 4 dBi

Cables 3 - 5: 2.4 - 2.5 & 4.9 - 6.0 GHz, 5 dBi

Cable 6: 1561, 1575 & 1602 MHz, 5 dBi

Dimensions: 5.50" (14cm) D x 2.38" (6.04cm) H

Shock and Vibration: IEEE1478, EN61373, MIL-810G, TIA 329.2-C

Water Ingress: IP67

*Specify **LTM601** for GPS only model

*Also available in black



LTMG602 (2xGlobal LTE, 3xWiFi & GNSS) Multiband Diversity/MIMO Antenna

Cables 1 & 2: 694 - 960 MHz, 3 dBi & 1710 - 3700 MHz 4 dBi

Cables 3 - 5: 2.4 - 2.5 & 4.9 - 6.0 GHz, 5 dBi

Cable 6: 1561, 1575 & 1602 MHz, 5 dBi

Dimensions: 5.50" (14cm) D x 2.38" (6.04cm) H

Shock and Vibration: IEEE1478, EN61373, MIL-810G, TIA 329.2-C

Water Ingress: IP67

*Specify **LTM602** for GPS only model

*Also available in black



LTMG610 (2xWideband, 3xWiFi & GNSS) Multiband to 6 GHz, MIMO Antenna

Cables 1 & 2: 694 - 960 MHz, 3 dBi & 1710 - 6000 MHz 5 dBi

Cables 3 - 5: 2.4 - 2.5 & 4.9 - 6.0 GHz, 5 dBi

Cable 6: 1561, 1575 & 1602 MHz, 5 dBi

Dimensions: 5.50" (14cm) D x 2.38" (6.04cm) H

Shock and Vibration: IEEE1478, EN61373, MIL-810G, TIA 329.2-C

Water Ingress: IP67

*Specify **LTM610** for GPS only model

*Also available in black



MXFG602 (2xGlobal LTE, 3xWiFi & GNSS) Multiband Diversity/MIMO Antenna

Cables 1 & 2: 694 - 960 MHz, 3 dBi & 1710 - 3700 MHz, 4 dBi

Cables 3 - 5: 2.4 - 2.5 & 4.9 - 6.0 GHz, 5 dBi

Cable 6: 1561, 1575 & 1602 MHz, 5 dBi

Dimensions: 7.5" (19cm) L x 2.25" (5.7cm) W x 2.5" (6.4cm) H

*Specify **MMXFG602** for mag-mount

*Specify **MXF602** (or **MMXF602**) for GPS only model





LLPG702 (2xGlobal LTE, 4xWiFi & GNSS) Low Profile Multiband Surface Mount Antenna

Cables 1 & 2: 694 - 960 MHz, 0 - 3 dBi & 1710 - 3700 MHz, 4 dBi

Cables 3 - 6: 2.4 - 2.5 GHz, 4 dBi & 5.0 - 6.0 MHz, 5 dBi

Cable 7: 1561, 1575 & 1602 MHz, 5 dBi

Dimensions: 9" (22.8cm) L x 3.5" (8.9cm) W x 1.5" (3.8cm) H

Shock and Vibration: IEEE1478, EN61373, MIL-810G, TIA 329.2-C

Water Ingress: IP67

*Specify **MLPG702** for mag-mount

*Specify **LLP702** (or **MLP702**) for GPS only Model

*Also available in Black



LTMG702 (2xGlobal LTE, 4xWiFi & GNSS) Multiband Diversity/MIMO Antenna

Cables 1 & 2: 694 - 960 MHz, 3 dBi & 1710 - 3700 MHz, 4 dBi

Cables 3 - 6: 2.4 - 2.5 & 4.9 - 6.0 GHz, 5 dBi

Cable 7: 1561, 1575 & 1602 MHz, 5 dBi

Dimensions: 5.50" (14cm) D x 2.38" (6.04cm) H

Shock and Vibration: IEEE1478, EN61373, MIL-810G, TIA 329.2-C

Water Ingress: IP67

*Specify **LTM702** for GPS only model

*Also available in black



MXFG702 (2xGlobal LTE, 4xWiFi & GNSS) Multiband Diversity/MIMO Antenna

Cables 1 & 2: 694 - 960 MHz, 3 dBi & 1710 - 3700 MHz 4 dBi

Cables 3 - 6: 2.4 - 2.5 & 4.9 - 6.0 GHz, 5 dBi

Cable 7: 1561, 1575 & 1602 MHz, 5 dBi

Dimensions: 7.5" (19cm) L x 2.25" (5.7cm) W x 2.5" (6.4cm) H

*Specify **MMXFG702** for mag-mount

*Specify **MXF702** (or **MMXF702**) for GPS only model



LTMG943 (4xGlobal LTE, 3xWiFi & GNSS) Dual Carrier Multiband Antenna

Cables 1 - 4: 694 - 960 MHz, 2 dBi & 1710 - 3700 MHz 5 dBi

Cables 5 - 7: 2.4 - 2.5 & 4.9 - 6.0 GHz, 5 dBi

Cable 8: 1561, 1575 & 1602 MHz, 5 dBi

Dimensions: 5.50" (14cm) D x 2.38" (6.04cm) H

*Specify **LTM943** for GPS only model

*Not available as a mag-mount

*Also available in black

*See spec sheet for cable assemblies options





LTMG944 (4xGlobal LTE, 4xWiFi & GNSS) Dual Carrier Multiband Antenna

Cables 1 - 4: 694 - 960 MHz, 2 dBi & 1710 - 3700 MHz 5 dBi

Cables 5 - 8: 2.4 - 2.5 & 4.9 - 6.0 GHz, 5 dBi

Cable 9: 1561, 1575 & 1602 MHz, 5 dBi

Dimensions: 5.50" (14cm) D x 2.38" (6.04cm) H

*Specify **LTM944** for GPS only model

*Not available as a mag-mount

*Also available in black

*See spec sheet for cable assemblies options



LTMWG944 (4xGlobal 5G LTE, 4xWiFi & GNSS) Dual Carrier Multiband Antenna

Cables 1 - 4: 617 - 960 MHz, 2 dBi & 1710 - 6000 MHz 5 dBi

Cables 5 - 8: 2.4 - 2.5 & 4.9 - 6.0 GHz, 5 dBi

Cable 9: 1561, 1575 & 1602 MHz, 5 dBi

Dimensions: 5.50" (14cm) D x 2.38" (6.04cm) H

*Specify **LTMW944** for GPS only model

*Not available as a mag-mount

*Also available in black

*See spec sheet for cable assemblies options

With the addition of the Comtelco Brand Antennas, Mobile Mark now offers a wider variety of Land Mobile Radio (LMR) antennas. Antennas are available for both Mobile/Vehicle installations as well as for Base Station/Infrastructure installations.

BS150UA-E Series

VHF Unity Gain Base Station Antenna

Frequency: 144 MHz - 174 MHz
Gain: Unity
Dimensions: 64" (1.62m) H x 1" (2.54cm) D
Bandwidth: 6 MHz
Model Numbers w/ Frequencies:
 BS150U-A - 144 - 150 MHz
 BS150U-B - 150 - 156 MHz
 BS150U-BS - 153 - 159 MHz
 BS150U-C - 156 - 162 MHz
 BS150U-D - 162 - 168 MHz
 BS150U-E - 168 - 174 MHz

BS450U Series

UHF Base Station Antenna

Frequency: 380 - 512 MHz
Gain: Unity
Dimensions: 36" (3.4cm) H x 1" (2.54cm) D
Bandwidth: >20 MHz

Model Numbers w/ Frequencies:

BS380U-A - 375 - 400 MHz
 BS450U-A - 406 - 430 MHz
 BS450U-B - 430 - 450 MHz
 BS450U-BC - 445 - 465 MHz
 BS450U-C - 450 - 470 MHz
 BS450U-CD - 460 - 480 MHz
 BS450U-D - 470 - 490 MHz
 BS450U-DE - 480 - 500 MHz
 BS450U-E - 490 - 512 MHz

BSL150XL3 Series

VHF Base Station Antenna

Frequency: 144-174 MHz
Gain: 3 dBd
Dimensions: 98" (2.49m) L x 1.35" (3.4cm) D
Bandwidth: 6 MHz

Model Numbers w/ Frequencies:

BSL150XL3-A - 144 - 148 MHz
 BSL150XL3-B - 150 - 156 MHz
 BSL150XL3-BC - 153 - 159 MHz
 BSL150XL3-C - 156 - 162 MHz
 BSL150XL3-D - 162 - 168 MHz
 BSL150XL3-E - 168 - 174 MHz

BS450XL6 Series

UHF Base Station Antenna

Frequency: 406 - 512 MHz
Gain: 6 dBd
Dimensions: 98" (2.49m) H x 1.35" (3.4cm) D
Bandwidth: >20 MHz

Model Numbers w/ Frequencies:

BS450XL6-AB - 406 - 440 MHz
 BS450XL6-BCD - 440 - 480 MHz
 BS450XL6-C - 450 - 470 MHz
 BS450XL3-DE - 480 - 512 MHz

BSL450U Series Base Station Antenna

Frequency: 380 - 512 MHz
Gain: Unity
Dimensions: 32" (81cm) H x 1.5" (4cm) D
Bandwidth: >20 MHz

Model Numbers w/ Frequencies:

BSL380U-A - 375 - 400 MHz
BSL450U-A - 406 - 430 MHz
BSL450U-B - 430 - 450 MHz
BSL450U-BC - 445 - 465 MHz
BSL450U-C - 450 - 470 MHz
BSL450U-CD - 460 - 480 MHz
BSL450U-D - 470 - 490 MHz
BSL450U-DE - 480 - 500 MHz
BSL450U-E - 490 - 512 MHz

BSL540XL4.5 Series UHF Base Station Antenna

Frequency: 406 - 512 MHz
Gain: 4.5 dBd
Dimensions: 67" (1.7m) H x 1.5" (4cm) D
Bandwidth: >20 MHz

Model Numbers w/ Frequencies:

BSL450XL4.5-A - 406 - 430 MHz
BSL450XL4.5-B - 430 - 450 MHz
BSL450XL4.5-C - 450 - 480 MHz
BSL450XL4.5-D - 470 - 490 MHz
BSL450XL4.5-E - 490 - 512 MHz

BSL450XL6 Series UHF Base Station Antenna

Frequency: 406 - 512 MHz
Gain: 6 dBd
Dimensions: 98" (2.48m) H x 1.5" (4cm) D
Bandwidth: >20 MHz

Model Numbers w/ Frequencies:

BSL450XL6-A - 406 - 440 MHz
BSL450XL6-B - 440 - 460 MHz
BSL450XL6-C - 450 - 470 MHz
BSL450XL6-D - 460 - 480 MHz
BSL450XL6-E - 480 - 512 MHz

BSLL450U Series Base Station Antenna

Frequency: 380 - 512 MHz
Gain: Unity
Dimensions: 32" (1.62cm) H x 2" (5.1cm) D
Bandwidth: >20 MHz

Model Numbers w/ Frequencies:

BSLL380U-A - 375 - 400 MHz
BSLL450U-A - 406 - 430 MHz
BSLL450U-B - 430 - 450 MHz
BSLL450U-BC - 445 - 465 MHz
BSLL450U-C - 450 - 470 MHz
BSLL450U-CD - 460 - 480 MHz
BSLL450U-D - 470 - 490 MHz
BSLL450U-DE - 480 - 500 MHz
BSLL450U-E - 490 - 512 MHz



BSLL450XL4.5 Series

UHF Base Station Antenna

Frequency: 406 - 512 MHz

Gain: 4.5 dBd

Dimensions: 67" (1.7m) H x 2" (5cm) D

Bandwidth: >20 MHz

Model Numbers w/ Frequencies:

BSLL450XL4.5-A - 406 - 430 MHz

BSLL450XL4.5-B - 430 - 450 MHz

BSLL450XL4.5-C - 450 - 480 MHz

BSLL450XL4.5-D - 470 - 490 MHz

BSLL450XL4.5-E - 490 - 512 MHz



BSLL450XL6 Series

UHF Base Station Antenna

Frequency: 406 - 512 MHz

Gain: 6 dBd

Dimensions: 98" (2.5m) H x 2" (5cm) D

Bandwidth: >20 MHz

Model Numbers w/ Frequencies:

BSLL450XL6-A - 406 - 440 MHz

BSLL450XL6-B - 440 - 460 MHz

BSLL450XL6-C - 450 - 470 MHz

BSLL450XL6-D - 460 - 480 MHz

BSLL450XL6-E - 480 - 512 MHz



BSLLL-150BB

VHF Base Station Antenna

Frequency: 148 - 176 MHz

Gain: 2 dBd

Dimensions: 56" (142.2cm) H x 2.75" (7cm) D

- Designed to cover the full Public Safety Spectrum band from 148 - 176 MHz
 - Law Enforcement
 - Fire
 - EMS
- Constructed of Copper Alloy and enclosed in a robust fiberglass radome to protect from the harshest outdoor environments
- Made in the USA



CLTM101 (UHF) UHF Ceiling Mount Antenna

Frequency: 420 - 470 MHz

Gain: Unity

Dimensions: 5.50" (140mm) D. x 2.38" (60.4mm) H

Shock & Vibration: IEEE1478, EN61373, MIL-810G, TIA 329.2-C

Water Ingress: IP67





ED450-1

Folded Dipole Antenna with Mounting Pole

Frequency: 406 - 512 MHz

Gain: 2.5 dBd

Dimensions: 60" (1.52m) H (including pole) x 22" (56cm) W

Bandwidth: 106 MHz

*Note: cable exits through pole



ED450-2

2x Folded Dipole Antenna with Mounting Pole

Frequency: 406 - 512 MHz

Gain: 5 dBd

Dimensions: 60" (1.52m) H (including pole) x 22" (56cm) W

Bandwidth: 106 MHz

*Note: cable exits through pole



EDX150

Exposed Cable Dipole Antenna

Frequency: 150 - 174 MHz

Gain: 2.5 dBd

Dimensions: 35" (88cm) H x 22" (56cm) W

Bandwidth: 106 MHz

*Pole not included, cable exits at end of antenna



EDX450

Exposed Cable Dipole

Frequency: 406 - 512 MHz

Gain: 2.5 dBd

Dimensions: 60" (1.5m) H x 22" (55cm) W

Bandwidth: 106 MHz

*Pole not included, cable extis at end of antenna



PH-150-2

2 Way VHF Phasing Harness

Frequency: 148 - 172 MHz

Phase Error: +/- 2° over Freq. Range

Connector: "N" Female

Water Ingress: IPx7

PH-150-4

4 Way VHF Phasing Harness

Frequency: 148 - 172 MHz

Phase Error: +/- 2° over Freq. Range

Connector: "N" Female

Water Ingress: IPx7

PH-450-2

2 Way UHF Phasing Harness

Frequency: 440 - 512 MHz

Phase Error: +/- 2° over Freq. Range

Connector: "N" Female

Water Ingress: IPx7

PH-450-4

4 Way UHF Phasing Harness

Frequency: 440 - 512 MHz

Phase Error: +/- 2° over Freq. Range

Connector: "N" Female

Water Ingress: IPx7

* Optimized for Mobile Mark/Comtelco EDX-150 & EDX-450 Folded Dipole Antennas



A1111 Series

Classic Mobile Antenna

Frequency: 136 - 512 MHz

Gain: Unity

Dimensions: 20" (51cm) H

Mounting: Standard TAD/NMO type

*Available in Brite or Black

Model Numbers & Frequencies:

A1111A (B) - 136: 136 - 144 MHz

A1111A (B) - 144: 144 - 150 MHz

A1111A (B) - 150: 150 - 162 MHz

A1111A (B) - 162: 162 - 174 MHz

A1111A (B) - 220: 220 - 225 MHz

A1111A (B) - 406: 406 - 430 MHz

A1111A (B) - 430: 430 - 450 MHz

A1111A (B) - 450: 450 - 470 MHz

A1111A (B) - 470: 470 - 490 MHz

A1111A (B) - 490: 490 - 512 MHz



A1511B Series

Broadband Mobile Antenna

Frequency: 132 - 512 MHz

Gain: Unity

Dimensions: 21" (53cm) H

Bandwidth: VHF 24 MHz, UHF 100 MHz

Mounting: Standard TAD/NMO type

*Available in Brite or Black



A1611BN Series

VHF & 220 MHz Antenna

Frequency: 150 - 174 MHz & 220 - 225 MHz

Gain: Unity

Dimensions: 3 1/4" (8.2cm) H x 3" (7.6cm) D

Mounting: Type "N" female termination

*Also available in white



A1801 Series

HF Base Loaded Antenna

Frequency: 24 - 54 MHz

Gain: Unity

Dimensions: 52" (1.3m) H

Mounting: Standard TAD/NMO type

Model Numbers & Frequencies:

A1801A-27: 27 - 31 MHz

A1801A-30: 30 - 35 MHz

A1801A-34: 34 - 40 MHz

A1801A-40: 40 - 47 MHz

A1801A-47: 47 - 54 MHz

A1801A-47: 47 - 54 MHz

*To order with shock spring add suffix S to the part number Ex. **A1801AS-27** or **A1801HAS-27**

*To order black version replace the series number A1801A with **A1801B**



A1813 Series

VHF & 220 MHz Base Loaded Antenna

Frequency: 132 - 280 MHz

Gain: 3 dB

Dimensions: 52" (1.3m) H

Mounting: Standard TAD/NMO type

*Available in Brite or Black

Model Numbers & Frequencies:

A1813A (B) - 32: 132 - 174 MHz

A1813A (B) - 44: 144 - 174 MHz

A1813A (B) - 00: 200 - 250 MHz

A1813A (B) - 50: 250 - 280 MHz

*To order with shock spring add suffix S to the part number. Example: **A1813AS-44** or **A1813BS-44**



A1842 Series

UHF No Ground Plane Antenna

Frequency: 406 - 512 MHz
Gain: Unity
Dimensions: 13.5" (34cm) H
Mounting: Standard TAD/NMO type
 *Available in Brite or Black

Model Numbers & Frequencies:

A1842A (B) - 06: 406 - 430 MHz
 A1842A (B) - 30: 430 - 450 MHz
 A1842A (B) - 50: 450 - 470 MHz
 A1842A (B) - 70: 470 - 490 MHz
 A1842A (B) - 90: 490 - 512 MHz



A1845 Series

Base Loaded Mobile Antenna

Frequency: 406 - 512 MHz
Gain: 5 dB
Dimensions: 39" (99cm) H
Mounting: Standard TAD/NMO type
 *Available in Brite or Black

Model Numbers & Frequencies:

A1845A (B) - 06: 406 - 430 MHz
 A1845A (B) - 30: 430 - 450 MHz
 A1845A (B) - 50: 450 - 470 MHz
 A1845A (B) - 70: 470 - 490 MHz
 A1845A (B) - 90: 490 - 512 MHz



A1843 Series

Base Loaded Mobile Antenna

Frequency: 406 - 512 MHz
Gain: 3 dB
Dimensions: 21" (53cm) H
Mounting: Standard TAD/NMO type
 *Available in Brite or Black

Model Numbers & Frequencies:

A1843A (B) - 06: 406 - 430 MHz
 A1843A (B) - 30: 430 - 450 MHz
 A1843A (B) - 50: 450 - 470 MHz
 A1843A (B) - 70: 470 - 490 MHz
 A1843A (B) - 90: 490 - 512 MHz



A2111 Series

Classic Mobile Antenna

Frequency: 136 - 512 MHz
Gain: Unity
Dimensions: 20" (50cm) H
Mounting: Magnet Mount
 *Available in Brite or Black

Model Numbers & Frequencies:

A2111A (B) - 136: 136 - 144 MHz
 A2111A (B) - 144: 144 - 150 MHz
 A2111A (B) - 150: 150 - 162 MHz
 A2111A (B) - 162: 162 - 174 MHz
 A2111A (B) - 220: 220 - 225 MHz
 A2111A (B) - 406: 406 - 430 MHz
 A2111A (B) - 430: 430 - 450 MHz
 A2111A (B) - 450: 450 - 470 MHz
 A2111A (B) - 470: 470 - 490 MHz
 A2111A (B) - 490: 490 - 512 MHz



A55136 VHF, UHF, Public Safety Antenna

Frequency: 136 - 174, 380 - 490 & 698 - 870 MHz
Gain: 3 dBi (VHF), 3 dBd (UHF)
Dimensions: 21" (53cm) H
Mounting: Standard TAD/NMO type



A1211 AC Series Classic Mobile Antenna

Frequency: 136 - 512 MHz
Gain: Unity
Dimensions: 24" (61cm) H
Mounting: Standard TAD/NMO Type

Model Numbers w/ Frequencies:
 A1211AC (BC) - 136: 136 - 144 MHz
 A1211AC (BC) - 144: 144 - 150 MHz
 A1211AC (BC) - 150: 150 - 162 MHz
 A1211AC (BC) - 162: 162 - 174 MHz
 A1211AC (BC) - 220: 220 - 225 MHz
 A1211AC (BC) - 406: 406 - 430 MHz
 A1211AC (BC) - 430: 430 - 450 MHz
 A1211AC (BC) - 450: 450 - 470 MHz
 A1211AC (BC) - 470: 470 - 490 MHz
 A1211AC (BC) - 490: 490 - 512 MHz



SMG-150/1575 Combination VHF & GNSS Antenna

Cable 1: 130 - 170 MHz, Unity
Cable 2: 1575 & 1602 MHz, 5 dBi
Dimensions: 18" (45cm) Whip Length
Base Dimension: 1" (2.5cm) H x 2 5/8" (6.7cm) D
Shock & Vibration: EN 61373, IEEE 1478, MIL-810G, TIA-326.2-C
Water Ingress: IPx5
 *Specify **SM-150/1575** for GPS only model



A46450BNT

UHF Stud Mount Antenna

Frequency: 450 - 512 MHz

Gain: 3 dBi

Dimensions: 4.25" (10.8cm) H x 1.36" (3.4cm) D.

*Also available in white



LTM101 (UHF)

Low Profile Dual Band Antenna

Frequency: 420 - 470 MHz

Gain: Unity

Dimensions: 5.50" (140mm) D x 2.38" (60.4mm) H

Shock & Vibration: IEEE1478, EN61373, MIL-810G, TIA 329.2-C

Water Ingress: IP67

*Also available in black



MXF-450

UHF Surface Mount Antenna

Frequency: 440 - 470 MHz

Gain: 2 dB

Dimensions: 4 1/8" (10cm) H x 1.5" (4cm) D

Water Ingress: IPx7



LLPG304 (Global LTE, UHF & GNSS)

Low Profile Multiband UHF Surface Mount Antenna

Cable 1: 694 - 4200 MHz, 4 dBi

Cable 2: 450 - 470 MHz, 3 dBi

Cable 3: 1561, 1575 & 1602 MHz, 5 dBi

Dimensions: 9" (22.8cm) L x 3.5" (8.9cm) W x 1.25" (3.18cm) H

Water Ingress: IP67

*Specify LLP304 for GPS only model

*Also available in white



Y3313 Series 3 Element Yagi Antenna

Frequency: 144 - 174 MHz
Gain: 6 dBd
Dimensions: 44" (1.1m) L x 38" (96.5cm) H
Bandwidth: 8 MHz

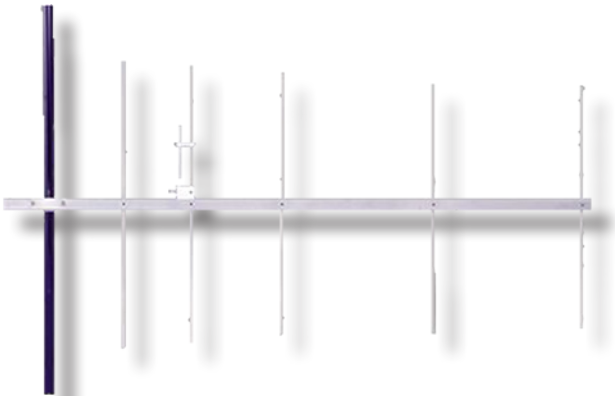

Y3315 Series 5 Element Yagi Antenna

Frequency: 144 - 174 MHz
Gain: 9 dBd
Dimensions: 74" (1.8M) L x 38" (96.5cm) H



Y3343 Series 3 Element Heavy Duty Yagi Antenna

Frequency: 406 - 512 MHz
Gain: 7 dBd
Dimensions: 32" (81cm) L

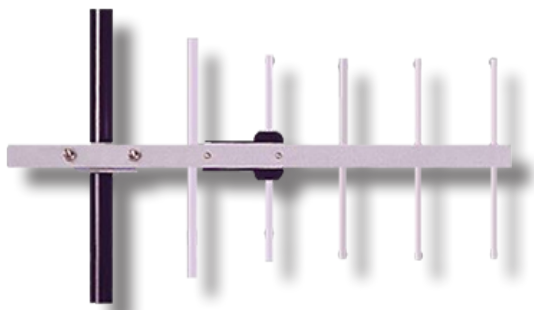

Y3345 Series 5 Element Heavy Duty Yagi Antenna

Frequency: 406 - 512 MHz
Gain: 8.8 dBd
Dimensions: 32" (81cm) L

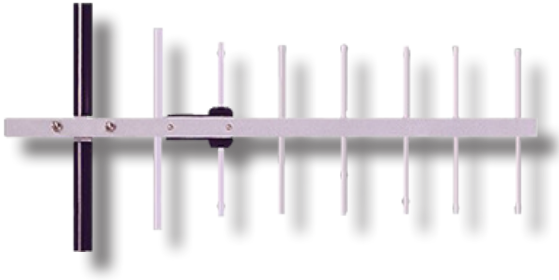

Y3347 Series

7 Element Heavy Duty Yagi Antenna

Frequency: 406 - 512 MHz
Gain: 10.4 dBd
Dimensions: 43" (1m) L

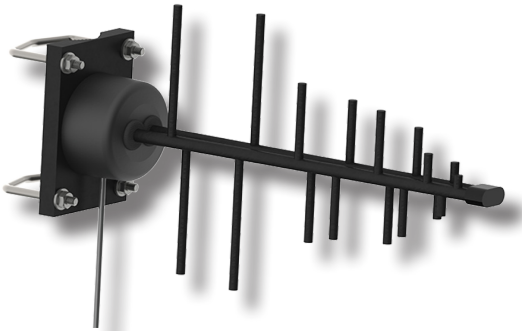

Y42400WB

Wideband Log Periodic Antenna

Frequency: 400 - 800 MHz
Gain: 9 dBi
Dimensions: 18.5" (47cm) L



Y6623 Series

3 Element Fully Welded Yagi Antenna

Frequency: 200 - 245 MHz
Gain: 7 dBd
Dimensions: 24" (61cm) L

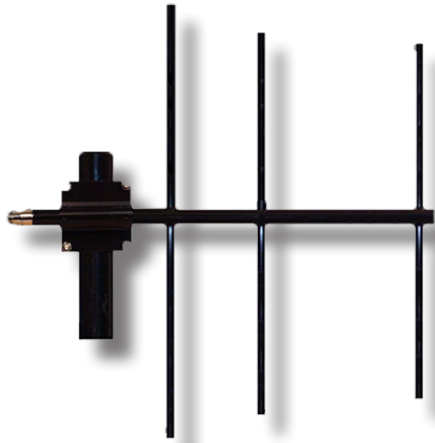

Y6633 Series

3 Element Fully Welded Yagi Antenna

Frequency: 325 - 345 MHz

Gain: 7 dBd

Dimensions: 24" (61cm) L x 18" (46cm) W



Y6646 Series

6 Element Fully Welded Yagi Antenna

Frequency: 400 - 512 MHz

Gain: 9.5 dB

Dimensions: 24" (61cm) L x 15" (38cm) W

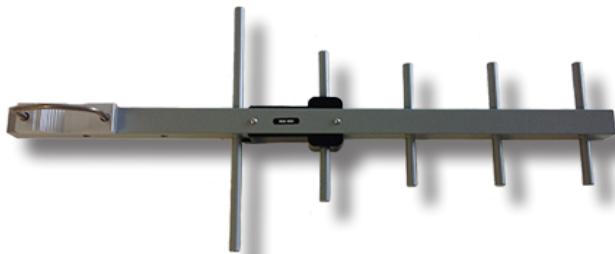

YAG8-450N

Directional Yagi Antenna

Frequency: 440 - 480 MHz

Gain: 8.8 dBd

Dimensions: 21" (81cm) L

Mobile Mark designed and manufactures Cellular Antennas that cover portions of or the full Cellular band within the entire 600-6000 MHz frequency range. The antennas are available in many different styles including small embedded and covert antennas, mid-sized mobile and fixed site antennas, and larger more robust infrastructure antennas



CVL-WLF

Covert Broadband Cellular Antenna

Frequency: 694 - 960 & 1700 - 2700 MHz

Gain: 2 dBi

Dimensions: 5 3/4" (14.6cm) L x 1 1/2" (3.8cm) W x 1/4" (.6cm) H

Shock and Vibration: EN61373, IEEE1478, MIL 810G, TIA 329.1-C

Water Ingress: IP69



PSGN-2000S

Device Antenna with Flexible Gooseneck Extension

Frequency: 1500 - 2700 MHz

Gain: 3 dBi

Dimensions: 7.125" (18.1cm) H x .44" (1.1cm) D

Water Ingress: IP67



PSKN3-700/2700S

Knuckle Swivel Device Antenna

Frequency: 694 - 960 & 1710 - 2700 MHz

Gain: 3 dBi peak

Dimensions: 7.75" (19.7cm) H when straight

Shock and Vibration: EN 61373, IEEE 1478, MIL-810G, TIA-329.2-C

Water Ingress: IPx5



PSKN3-900/1900S

Device Antenna

Frequency: 824 - 894 & 1850 - 1990 MHz

Gain: 3 dBi peak

Dimensions: 7.75" (19.7cm) H when straight

Shock and Vibration: EN 61373, IEEE 1478, MIL-810G, TIA-329.2-C

Water Ingress: IPx5

*Knuckle-Swivel style



PSKN3-925S

Device Antenna

Frequency: 870 - 960 MHz

Gain: 2.3 dBi max

Dimensions: 9" (229mm) H when straight

Shock and Vibration: EN61373, IEEE1478, MIL-810G, TIA 329.2-C

Water Ingress: IPx7

*Knuckle-Swivel Style



PSN3-925S

Halfwave Device Antenna

Frequency: 925 MHz

Gain: 3 dBi

Dimensions: 9" (229mm) H

Shock and Vibration: EN61373, IEEE1478, MIL-810G, TIA 329.2-C

Water Ingress: IPx7

*Fixed straight style



PSTGO-900/1900HKS Quarterwave Device Antenna

Frequency: 824 - 870 & 1850 - 1990 MHz
Gain: Unity
Dimensions: 1.6" (41mm) H
Water Ingress: IPx5



PSTGO-925HKS Quarterwave Device Antenna

Frequency: 870-960 MHz
Gain: Unity
Dimensions: 1.6" (41mm) L
Water Ingress: IPx5



PSTGO-925SE Quarterwave Device Antenna

Frequency: 860 - 960 MHz
Gain: Unity
Dimensions: 2.875" (73mm) H
Water Ingress: IPx5



PSKN3-3500T Knuckle Swivel CBRs Device Antenna

Frequency: 3400 - 3700 MHz
Gain: 2.3 dBi
Dimensions: 3 1/8" (79mm) when straight
Shock and Vibration: EN 61373, IEEE 1478, MIL-810G, TIA-329.2-C
Water Ingress: IPx5





EM-700/2700

Internal Embedded Antenna

Frequency: 694 - 960 MHz & 1710 - 2750 MHz

Gain: 0 dBi & 2.5 dBi

Dimensions: 4.96" (12.6cm) L x .53" (1.3cm) W



EM-900/1900

Internal Circuit Board Antenna

Frequency: 824 - 894 & 1850 - 1900 MHz

Gain: Unity

Dimensions: 3.2" (81cm) L x .95" (2.4cm) W



EM-925/1800

Internal Circuit Board Antenna

Frequency: 870 - 960 & 1710 - 1880 MHz

Gain: Unity

Dimensions: 3.2" (81cm) L x .95" (2.4cm) W

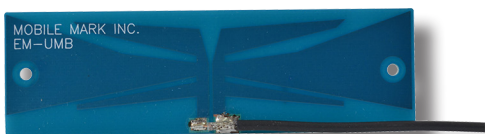

EM-UMB

Internal Circuit Board Antenna

Frequency: 824 - 960 & 1500 - 2200 MHz

Gain: 2 dBi

Dimensions: 4.5" (11.4cm) L x 1.17" (3cm) W

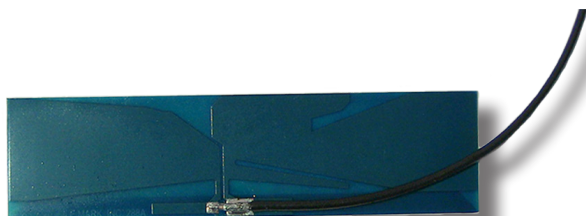

EM-LTE

Flexible LTE Internal Strip Antenna

Frequency: 695 - 960 & 1710 - 2700 MHz

Gain: 2 dBi

Bend Radius: 2.5" (6.35cm)

Dimensions: 5.4" (13.7cm) L x 1.3" (3.4cm) W



MGD-2600

Mag-Mount Antenna

Frequency: 2.5 - 2.7 GHz

Gain: 2.5 dBi

Dimensions: 3.75" (95mm) D x 1.9" (48mm) H

Shock & Vibration: EN 61373, IEEE1478, MIL-810G, TIA-329.2-C

Water Ingress: IP67



ECOM6-3500

5G Ready CBRS Mag-Mount Antenna

Frequency: 3.4 - 3.7 GHz

Gain: 6 dBi

Dimensions: 11.87" (30.15cm) H

Mag Base: 2.6" (6.6cm) D



A1083B

Elevated Feed Mobile Antenna

Frequency: 806-970 MHz

Gain: 3 dBd

Dimensions: 23" (58cm) H

Mounting: Standard TAD/NMO



A1483

M Type Mobile Antenna

Frequency: 806 - 960 MHz

Gain: 3 dBd

Dimensions: 15" (38cm) H

Mounting: Standard TAD/NMO



A46DB630B

LTE Surface Mount Antenna

Frequency: 698 - 960 MHz, 1850 - 2200 MHz

Gain: >Unity

Dimensions: 4 1/8" (10cm) H x 1.5" (4cm) D

Mounting: Standard TAD/NMO

*Also available in white



B46DB630WN

LTE Surface Mount Antenna

Frequency: 698 - 960 MHz, 1850 - 2200 MHz

Gain: >Unity

Dimensions: 4 1/8" (10cm) H x 1.5" (4cm) D

Mounting: "N" Type Connector

*Also available in black



A158192B

LTE Surface Mount Antenna

Frequency: 698 - 960 & 1850 - 2200 MHz

Gain: 2 dBd

Dimensions: 4" (10cm) H

Mounting: Standard TAD/NMO

*Also available in white



A25764B

Low Profile Mobile Antenna

Frequency: 794 - 896 MHz

Gain: Unity

Dimensions: 1 1/2" (4cm) H x 4 1/4" (10.7cm) D

Mounting: Standard TAD/NMO

*Also available in white



RMM-UMB

Heavy Duty Cellular Surface Mount Antenna

Frequency: 750 - 1250 & 1650 - 2700 MHz

Gain: 3 & 5 dBi

Dimensions: 1.7" (4.3cm) D x 3" (7.6cm) H

Shock & Vibration: EN 61373, IEEE 1478, MIL-810G TIA-329.2-C

Water Ingress: IP67

*Also available in white

*Also available in a Direct N Mount, **RMM-UMB-DN**



RM-WLF-DN

Heavy Duty Direct N Surface Mount LTE Antenna

Frequency: 694 - 894 MHz & 1.7 - 2.7 GHz

Gain: 3 & 5 dBi

Dimensions: 1.7" (4.3cm) D x 3" (7.6cm) H

Shock & Vibration: EN 61373, IEEE 1478, MIL-810G TIA-329.2-C

Water Ingress: IP67

*Also available in white

*Also available in Surface Mount, **RM-WLF** with cable pig tail



RM-WB1-DN

Sub-6 Direct N Surface Mount Antenna

Frequency: 617 - 960 & 1700 - 6000 MHz

Gain: 3 dBi

Dimensions: 1.7" (4.3cm) D x 3" (7.6cm) H

Water Ingress: IPx7

*Also available in white

*Also available in Surface Mount, **RM-DN** with cable pig tail



MRM3-3500

Low Profile CBRS Surface Mount Antenna

Frequency: 3.5 - 3.7 GHz

Gain: 2.5 dBi

Dimensions: 1" (25mm) D x 1.35" (34mm) H

Shock & Vibration: EN 61373, IEEE 1478, MIL-810G TIA-329.2-C

Water Ingress: IP67

*Also available in white



SM-900/1900

Surface Mount Cellular Antenna

Frequency: 824 - 870 & 1850 - 1990 MHz

Gain: Unity

Dimensions: 4.5" (11.4cm) D x .95" (2.4cm) H

Shock & Vibration: EN 61373, IEEE 1478, MIL-810G, TIA-329.2-C

Water Ingress: IPx5

*Also available in Black



DM2 - 3500

Low Profile 5G ready CBRS Dome Antenna

Frequency: 3400 - 3700 MHz

Gain: 2.5 dBi

Dimensions: 3" (76cm) D x 1.5" (38mm) H

Shock & Vibration: EN61373, IEEE 1478, MIL-810G, TIA-329.2-C

Water Ingress: IPx5

*Also available in Black



ECOS6-3500

Spring Mount 5G Ready CBRS Antenna

Frequency: 3.4-3.7 GHz

Gain: 6 dBi

Dimensions: 16.25" (41.3cm) H x .62" (1.6cm) D

Water Ingress: IPx5

LLP202 (2xGlobal LTE)

Low Profile IoT Surface Mount Antenna

Cables 1 & 2: 694 - 960 & 1710 - 3700 MHz

Gain: 3 & 4 dBi

Dimensions: 9" (22.8cm) L x 3.5" (8.9cm) W x 1.25" (3.18cm) H

Shock & Vibration: IEEE 1478, EN61373, MIL-810G, TIA-329.2-C

Water Ingress: IP67

* Also available in white



SMD-3500

5G ready Surface Mount Antenna

Frequency: 2.1 - 2.7 & 3.3 - 3.8 GHz

Gain: 4 dBi

Dimensions: 3.5" (89mm) D x 1.5" (38mm) H

Shock & Vibration: EN61373, IEEE1478, MIL-810G, TIA-329.2-C

Water Ingress: IPx7

*Also available in black





CLTM301 (2xLTE)

Cellular & 4G LTE Ceiling Mount Antenna

Cables 1 & 2: 694 - 960 & 1710 - 2170 MHz

Gain: 3 & 4 dBi

Dimensions: 5.50" (140mm) D x 2.38" (60.4mm) H

Shock & Vibration: IEEE1478, EN61373, MIL-810G, TIA 329.2-C



CLTM302 (2xGlobal LTE)

Cellular & 4G LTE Ceiling Mount Antenna

Cables 1 & 2: 694 - 960 & 1710 - 3700 MHz

Gain: 3 & 4 dBi

Dimensions: 5.50" (140mm) D x 2.38" (60.4mm) H

Shock & Vibration: IEEE1478, EN61373, MIL-810G, TIA 329.2-C



CLTM501 (2xLTE & 2xWiFi)

Cellular & 4G LTE Ceiling Mount Antenna

Cables 1 & 2: 694 - 960, 3 dBi & 1710 - 2170 MHz, 4 dBi

Cables 3 & 4: 2.4 - 2.5 & 1.9 - 6.0 GHz, 5 dBi

Dimensions: 5.50" (140mm) D x 2.38" (60.4mm) H

Shock & Vibration: IEEE1478, EN61373, MIL-810G, TIA 329.2-C



CMD-3500

5G Ready CBRS Ceiling Mount Antenna

Frequency: 2.1 - 2.7 & 3.3 - 3.8 GHz

Gain: 4 dBi

Dimensions: 3.5" (89cm) D x 1.5" (38cm) H



PND10-700/2700

2xMIMO Panel Directional Antenna

Frequency: 695 - 960 MHz, 9 dBi

1710 - 2170 MHz, 10 dBi

2400 - 2700 MHz, 10 dBi

Beamwidth: 695 - 960 MHz, 59° EL, 65° AZ

1710 - 2700 MHz, 37° EL, 60° AZ

Dimensions: 15" (38cm) H x 15" (38cm) W x 2.32" (5.9cm) D



PNM2-LTE

2xMIMO Omni-Directional Wall Mount Antenna

Frequency: 694 - 960 & 1710 - 2700 MHz

Gain: 2 dBi

Dimensions: 5.75" (14.6cm) H x 5.75" (14.6cm) W x .7" (1.8cm) D



PS12-2600-90

Sector Panel Antenna

Frequency: 2.5 - 2.7 GHz

Gain: 12 dBi

Beamwidth: 90° AZ, 22° EL

Dimensions: 12.5" (32cm) H x 3" (7.6cm) W



PS10-3500-120 Sector Panel Antenna

Frequency: 3.5 GHz
Gain: 10 dBi
Beamwidth: 120° AZ, 17° EL
Dimensions: 12.5" (32cm) H x 3" (7.6cm) W x 1.25" (3.2cm) D



PS12-3500-60 Sector Panel Antenna

Frequency: 3.5GHz
Gain: 12 dBi
Beamwidth: 60° AZ, 17° EL
Dimensions: 12.5" (32cm) H x 3" (7.6cm) W x 1.25" (3.2cm) D



SCR11-1800 Corner Reflector

Frequency: 1800 Mhz
Gain: 11 dBi
Beamwidth: 39° AZ, 50° EL
Dimensions: 7" (178mm) H x 7" (178mm) W
Shock & Vibration: EN 300 019-2-4, IEC 60068



SCR12-2600 Corner Reflector

Frequency: 2.5 - 2.7 GHz
Gain: 12 dBi
Beamwidth: 39° AZ, 50° EL
Dimensions: 7" (178mm) H x 7" (178mm) W
Shock & Vibration: EN 300 019-2-4, IEC 60068

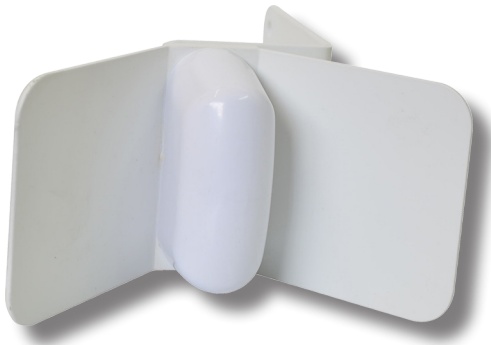

SCR10-3500

Corner Reflector

Frequency: 3.4 - 3.7 GHz

Gain: 10 dBi

Beamwidth: 36° AZ, 87° EL

Dimensions: 3" (76mm) H x 5.5" (140mm) W x 1.16" (30mm) D

Shock & Vibration: EN 300 019-2-4, IEC 60068



YAG9-3500

Directional Site Yagi Antenna

Frequency: 3.5 GHz

Gain: 9 dBi

Dimensions: 2.75" (7cm) H x 7.5" (19cm) L x .56" (1.4cm) W

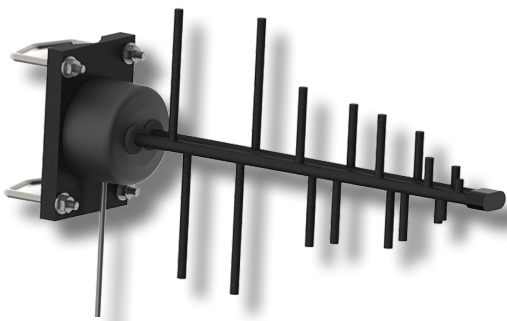

Y42700WB

Sub-6, 5G Ready Wideband Log Periodic Antenna

Frequency: 600 - 4200 & 4200 - 6000 MHz

Gain: 14 & 6 dBi

Dimensions: 18.5" (47cm) L



Y42700WB-2X

2xMIMO Sub-6m 5G Ready Log Periodic with Mount

Frequency: 600 - 4200 & 4200 - 6000 MHz

Gain: 14 & 6 dBi

Dimensions: 18.5" (47cm) L

*Dual Log Periodic Antennas with Mounting Bracket

*Provides Wideband 2xMIMO Coverage



TMA-WB1

Wideband Tactical Mesh Antenna

Frequency: 420 MHz - 6 GHz

Peak Gain:

- 420-698 MHz: 5 dBi
- 698-1850 MHz: 3 dBi
- 1850-2400 MHz: 5 dBi
- 2400-3700 MHz: 6 dBi
- 3700-4900 MHz: 7 dBi
- 4900-6000 MHz: 8 dBi

Dimensions: 5.5" (140mm) H x 4.4" (112mm) D



BS750U-WB

Wideband Base Station Antenna

Frequency: 746-896 MHz

Gain: Unity

Dimensions: 30" (76cm) H

Bandwidth: >150 MHz



BS1850XL6

Omni-Directional Base Station Antenna

Frequency: 1850 - 1990 MHz

Gain: 6 dBd

Dimensions: 24" (61cm) H

Bandwidth: 140 MHz @ <2.0:1



DOD7-700/2700

Omni-Directional 2xMIMO Antenna

Frequency: 694 - 960 & 1710 - 2700 MHz

Gain: 5 & 7 dBi

Dimensions: 50 1/2" (128cm) H x 2" (5.1cm) D

*Cable Jumpers available separately

*Brackets sold separately



DOD3-700/2700

Omni-Directional 3xMIMO Antenna

Frequency: 694 - 960 & 1700 - 2700 MHz

Gain: 2 & 3 dBi

Dimensions: 29 5/8" (75cm) H x 1" (2.5cm) D

Shock & Vibration: EN 300 019-2-4, IEC 60068

Water Ingress: IPx5



BSM698FS3BKT
Omni-Directional LTE Antenna

Frequency: 698-2700 MHz
Gain: 3 dBd
Dimensions: 8" (20cm) H x 1.38" (3.5cm) D
 *Antenna with mounting bracket



BSM3500FS3BKT
Omni-Directional CBRS Antenna

Frequency: 3550 - 3700 MHz
Gain: 5 dBi
Dimensions: 8" (20cm) H x 1.38" (3.5cm) D
 *Antenna with mounting bracket



BSDB18U8
Base Station Cellular Antenna

Frequency: 824 - 896 & 1850 - 1990 MHz
Gain: 3 dBd
Dimensions: 1 8" (46cm) L

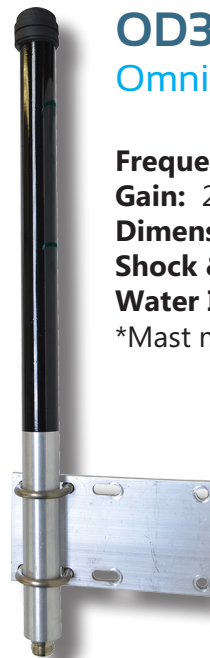

OD3-700/2700
Omni-Directional LTE Site Antenna

Frequency: 694 - 960 & 1710 - 2700 MHz
Gain: 2 & 3 dBi
Dimensions: 17.25" (44.4cm) H x 1" (2.5cm) D
Shock & Vibration: EN 300 019-2-4. IEC 60068
Water Ingress: IPx5
 *Mast mount kit included



OD6-700

Omni-Directional FirstNet Site Antenna

Frequency: 694 - 806 MHz

Gain: 6 dBi

Dimensions: 38" (97cm) H x 1" (2.5cm) D

Shock & Vibration: EN300 019-2-4, IEEE 60068

Water Ingress: IPx5

*Mast mount kit included



OD6-1900

Omni-Directional Site Antenna

Frequency: 1850 - 1990 MHz

Gain: 6 dBi

Dimensions: 22" (55.9cm) H x 1" (2.5cm) D

Shock & Vibration: EN300 019-2-4, IEEE 60068

Water Ingress: IP67

*Mast mount kit included



OD6-2000

Omni-Directional Antenna

Frequency: 1710 - 2170 MHz

Gain: 6 dBi

Dimensions: 26.75" (67.9cm) H x 1" (2.5cm) D

Shock & Vibration: EN300 019-2-4, IEEE 60068

Water Ingress: IPx5

*Mast mount kit included

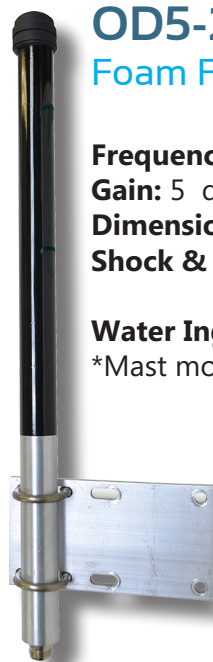

OD5-2000MOD2

Foam Filled Omni-Directional Antenna

Frequency: 1710 - 2170 MHz

Gain: 5 dBi

Dimensions: 26.75" (67.9cm) H x 1" (2.5cm) D

Shock & Vibration: IEEE1478, EN61373,
MIL-810G, TIA 329.2-C

Water Ingress: IP67

*Mast mount kit included



OD3-700/2700 DN

Omni-Directional Recessed N LTE Site Antenna

Frequency: 694 - 960 & 1710 - 2700 MHz

Gain: 2 & 3 dBi

Dimensions: 10" (25.4cm) H x 1" (2.5cm) D

Shock & Vibration: EN300 019-2-4, OEC 60067

Water Ingress: IPx5



DOD7-3500

Omni-Directional 3xMIMO CBRS Antenna

Frequency: 3.4 - 3.7 GHz

Gain: 7 dBi

Dimensions: 40" (101.6cm) H x 1" (2.5cm) D

Shock & Vibration: EN 300 019-2-4, IEC 60068

Water Ingress: IPx5

*Mast mount kit included



OD-850/1900

Omni-Directional Cellular Site Antenna

Frequency: 842 - 894 & 1850 - 1990 MHz

Gain: 4 & 5 dBi

Dimensions: 29.4" (74.9cm) H x 1" (2.5cm) D

Shock & Vibration: EN 300 019-2-4, IEC 60068

Water Ingress: IPx5

*Mast mount kit included

US location:

Mobile Mark, Inc.
1140 W. Thorndale Ave.
Itasca, IL 60143, USA

- Global Headquarters
- Engineering design center
- Environmental testing facilities
- Expanded manufacturing space

Toll free: 1-800-648-2800 (US & Canada)
Phone: 1-847-671-6690
Fax: 1-847-250-5120
Email: info@mobilemark.com

UK location:

Mobile Mark Europe, Ltd.
8 Miras Business Park
Hednesford, Staffordshire, WS12 2FS, UK

- European production facility
- Expanded manufacturing space
- ISO-9001 certified

Phone: +44 1543 459555
Fax: +44 1543 459545
Email: enquiries@mobilemarkeurope.co.uk

Distributors:

For a complete listing, visit:
www.MobileMark.com

